

LOC		DIST		REVISIONS			
P	LTN	DESCRIPTION	DATE	DMN	APVD		
P4		REV PER ECR-13-015977	14OCT2013	CZ	SZ		
P5		REV PER ECR-13-004893	25NOV2013	ML	SZ		
P6		ADD NEW PART 5-6600333-2	11OCT2014	AY	SZ		
P7		REV PER ECR-15-007162	04MAY2015	CZ	SZ		

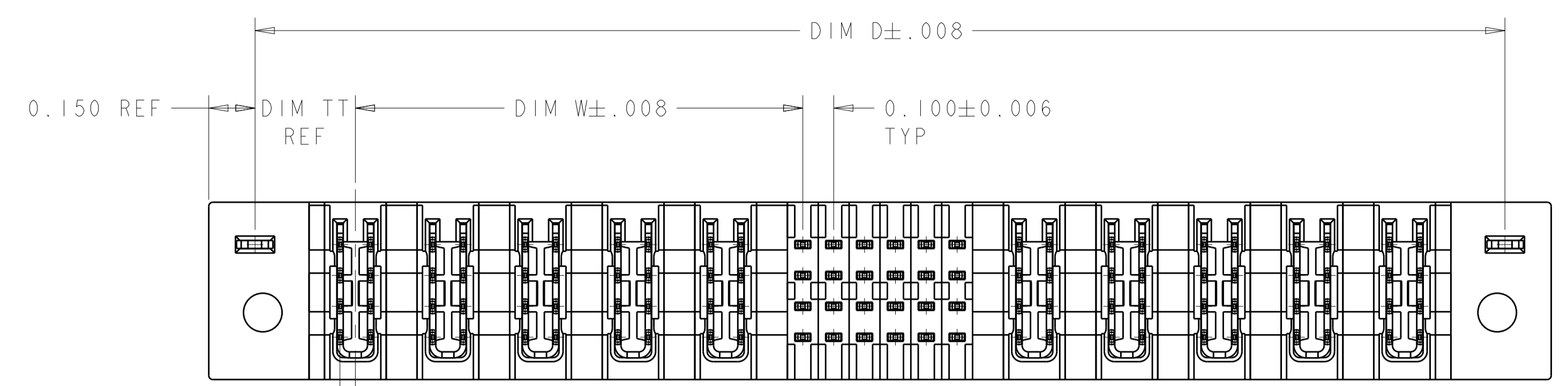

0.050 REF TYP

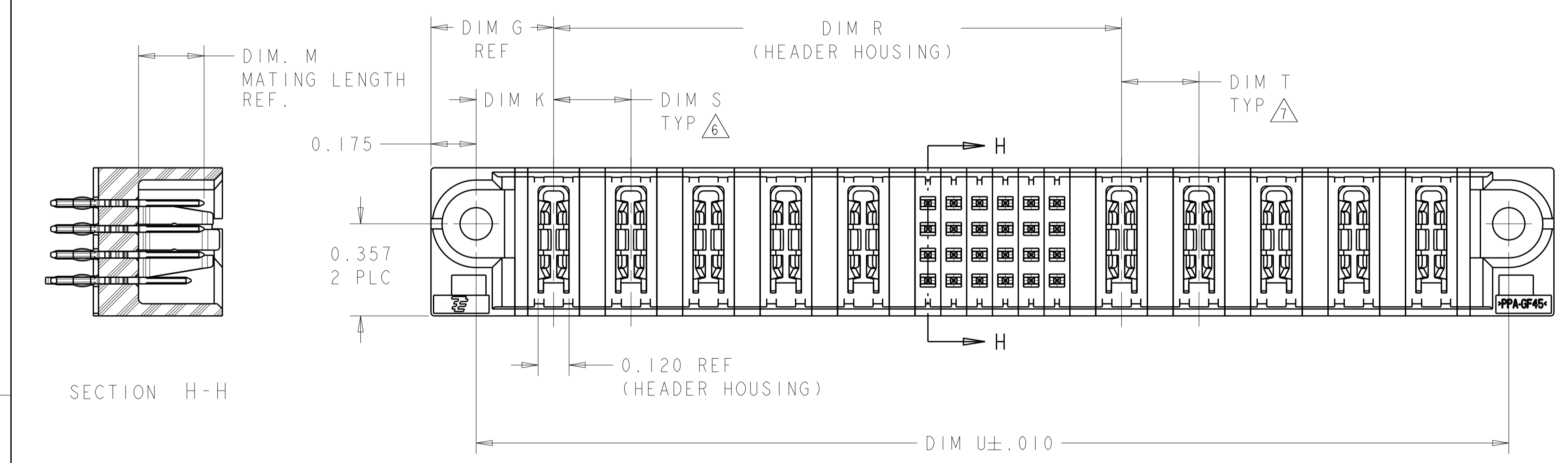
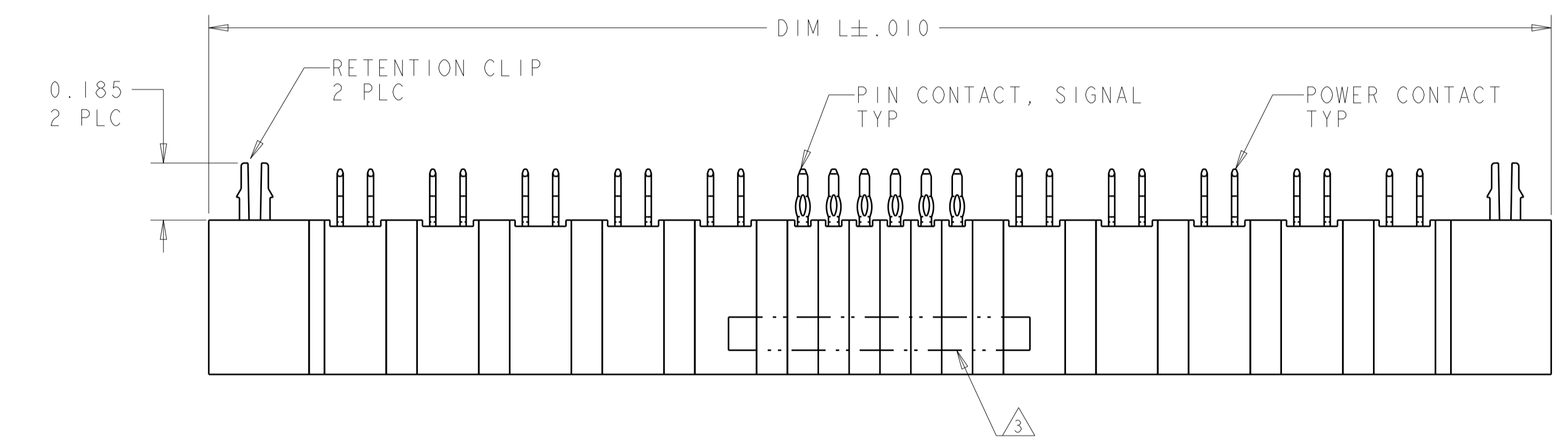

- 1. HEADER HOUSING: THERMO PLASTIC, BLACK, UL94 V-0; CONTACTS AND RETENTION CLIPS: COPPER ALLOY.
- 2. CONTACT PLATING: NOBLE METAL PLATING ON CONTACT FUNCTIONAL AREA OF POWER AND SIGNAL CONTACTS
- 3. "AMP", PART NUMBER AND DATE CODE MARKED IN THIS AREA. PARTS UNDER 2.50 LONG MAY BE MARKED ON BOTH SIDES.
- 4. DATUM AND BASIC DIMENSIONS ESTABLISHED BY CUSTOMER.
- 5. PCB - ALL HOLE DIAMETERS ARE FINISHED HOLE SIZES.
- 6. APPLIES TO POWER MODULES ON LEFT SIDE OF SIGNAL CAVITIES OF HOUSING.
- 7. APPLIES TO POWER MODULES ON RIGHT SIDE OF SIGNAL CAVITIES OF HOUSING.
- 8. A SEATING TOOL IS REQUIRED TO SEAT THE HEADER ON THE P.C. BOARD. PLEASE REFER TO THE 114-13038 APPLICATION SPEC.
- 9. MECHANICAL CONNECTOR KEEP OUT ZONE.
- 10. VARIABLE DIMENSION SHOWN VIEW. (SEE SHEET 6)

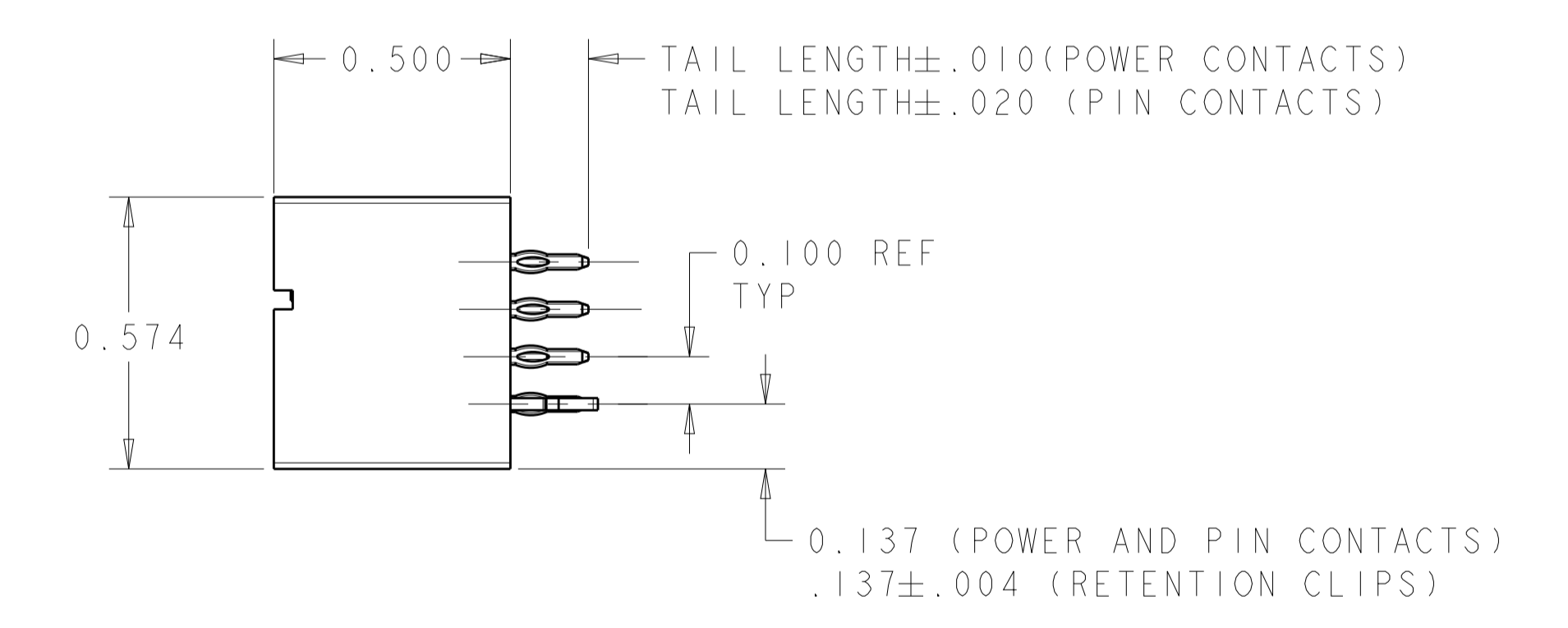

THIS DRAWING IS A CONTROLLED DOCUMENT.		DMN J. McCLINTON 23MAR2005	TE Connectivity
DIMENSIONS: INCH		CHK D. TROUT 23MAR2005	
TOLERANCES UNLESS OTHERWISE SPECIFIED:		APVD B. MLYNE 23MAR2005	NAME VERTICAL HEADER ASSEMBLY, W/GUIDES, PRESS FIT, TYPE PSP MULTI-BEAM XL
0 PLC ±. 1 PLC ±.01 2 PLC ±.01 3 PLC ±.005 4 PLC ±.0020 ANGLES ±.7°		PRODUCT SPEC 108-1973	SIZE A1
MATERIAL		APPLICATION SPEC 114-13038	CAGE CODE DRAWING NO C=6600333
FINISH		WEIGHT	RESTRICTED TO
		Customer Drawing	SCALE 3:1 SHEET 1 OF 22 REV P7

LOC	DIST	REVISIONS					
		P	LTN	DESCRIPTION	DATE	OWN	APVD
ES	00	-	-	SEE SHEET 1	-	-	-

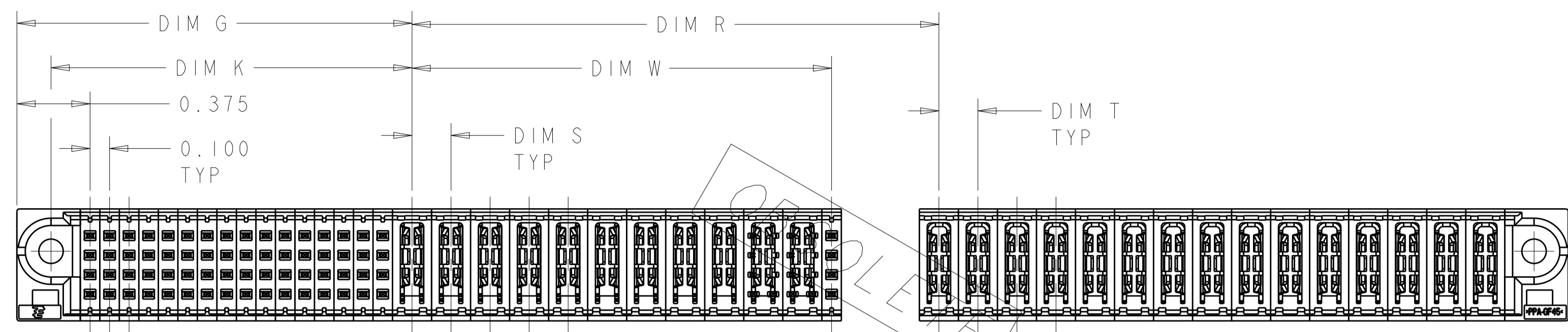

PART NUMBER 2-6600333-3
 UNSPECIFIED REFER TO TEH SHEET 1

	DIM "TT"	DIM "W"	DIM "U"	DIM "T"	DIM "S"	DIM "R"	DIM "L"	DIM "K"	DIM "G"	DIM "D"	RETENTION CLIP	DESCRIPTION	PART NO
P6	.300	.425	2.500	.250	.250	1.700	2.850	.275	.450	2.550	NO	2P + 48S + 2P	5-6600333-2
	.300	1.425	4.250	.250	.250	2.700	4.600	.275	.450	4.300	NO	6P + 48S + 5P	5-6600333-1
P1	.300	.425	2.400	.250	.250	1.100	2.750	.275	.450	2.450	NO	2P + 24S + 4P	5-6600333-0
	.300	.175	1.100	-	-	.550	1.450	.275	.450	1.150	YES	1P + 12S + 1P	4-6600333-9
N7	.300	1.225	4.000	.250	.250	2.200	4.350	.275	.450	4.057	NO	5P + 24S + 6P	4-6600333-8
N3	.300	.925	2.600	.250	.250	1.300	2.950	.275	.450	2.650	YES	4P + 12S + 4P	4-6600333-6
N5	.325	.550	2.200	.300	.300	1.300	2.550	.300	.475	2.250	YES	2ACP + 24S + 2ACP	4-6600333-5
	.300	.425	1.900	.250	.250	1.100	2.250	.275	.450	1.950	YES	2P + 24S + 2P	4-6600333-4
N4	.325	.550	2.200	.300	.300	1.300	2.550	.300	.475	2.250	YES	2ACP + 24S + 2ACP	4-6600333-3
	.300	1.925	4.700	.250	.250	2.400	5.050	.275	.450	4.750	YES	8P + 16S + 8P	4-6600333-2
	.300	.425	1.600	.250	.250	.800	1.950	.275	.450	1.650	YES	2P + 12S + 2P	4-6600333-1
	.325	.850	2.800	.300	.300	1.600	3.150	.300	.475	2.850	YES	3ACP + 24S + 3ACP	3-6600333-9
	.300	1.425	3.500	.250	.250	1.700	3.850	.275	.450	3.550	YES	6P + 8S + 6P	3-6600333-8
	.300	.475	2.000	.250	.250	1.200	2.350	.275	.450	2.050	YES	2P + 24S + 2P	3-6600333-7
	.300	.925	3.700	.250	.250	2.400	4.050	.275	.450	3.750	NO	4P + 56S + 4P	3-6600333-6
	.300	.675	2.400	.250	.250	1.350	2.750	.275	.450	2.450	YES	3P + 24S + 3P	3-6600333-5
	.300	.925	2.500	.250	.250	1.200	2.850	.275	.450	2.550	YES	4P + 8S + 4P	3-6600333-4
	.300	.925	2.700	.250	.250	1.400	3.050	.275	.450	2.750	NO	4P + 16S + 4P	3-6600333-3
	.300	.925	2.900	.250	.250	1.600	3.250	.275	.450	2.950	NO	4P + 24S + 4P	3-6600333-2
	.325	1.750	4.800	.250	.300	2.475	5.150	.300	.475	4.850	YES	6ACP + 24S + 8P	3-6600333-1
	.300	.225	1.300	-	-	.750	1.650	.275	.450	1.350	YES	1P + 16S + 1P	3-6600333-0
	.300	.425	2.100	-	.250	1.300	2.450	.275	.450	2.150	YES	2P + 32S + 2P	2-6600333-9
	.300	.925	2.450	.250	.250	1.400	2.800	.275	.450	2.500	YES	4P + 16S + 3P	2-6600333-8
	.300	.975	3.250	.250	.250	1.700	3.600	.275	.450	3.300	YES	4P + 24S + 5P	2-6600333-7
	.300	.675	2.400	.250	.250	1.350	2.750	.275	.450	2.450	YES	3P + 24S + 3P	2-6600333-6
	.300	.925	2.450	.250	.250	1.400	2.800	.275	.450	2.500	YES	4P + 16S + 3P	2-6600333-5
	.275	2.000	5.450	△	△	2.650	5.800	.250	.425	5.500	YES	10P + 24S + 12P	2-6600333-4
	1.875	2.150	7.600	.200	.200	2.700	7.950	1.850	2.025	7.650	YES	64S+11P+20S+15P	2-6600333-3
	.275	2.000	5.450	△	△	2.650	5.800	.250	.425	5.500	YES	10P + 24S + 12P	2-6600333-2
	.325	1.750	4.800	.250	.300	2.475	5.150	.300	.475	4.850	YES	6ACP + 24S + 8P	2-6600333-1
	.300	.475	2.000	.250	.250	1.200	2.350	.275	.450	2.050	YES	2P + 24S + 2P	1-6600333-6
	.300	1.425	3.900	.250	.250	2.100	4.250	.275	.450	3.950	YES	6P + 24S + 6P	1-6600333-5
	.300	.975	3.200	.250	.250	1.900	3.550	.275	.450	3.250	YES	4P + 32S + 4P	1-6600333-4
	.300	1.425	3.900	.250	.250	2.100	4.250	.275	.450	3.950	YES	6P + 24S + 6P	1-6600333-3
	.300	.425	1.900	.250	.250	1.100	2.250	.275	.450	1.950	YES	2P + 24S + 2P	1-6600333-2
	.325	.850	2.800	.300	.300	1.600	3.150	.300	.475	2.850	YES	3ACP + 24S + 3ACP	1-6600333-1
	.300	.475	1.800	.250	.250	1.000	2.150	.275	.450	1.850	YES	2P + 16S + 2P	1-6600333-0
	.300	.225	1.300	-	-	.750	1.650	.275	.450	1.350	YES	1P + 16S + 1P	6600333-9
	.300	.425	3.250	-	.250	2.700	3.600	.275	.450	3.300	YES	2P + 88S + 1P	6600333-8
	.300	.725	2.300	.250	.250	1.250	2.650	.275	.450	2.350	YES	3P + 16S + 3P	6600333-7
	.300	.975	3.000	.250	.250	1.700	3.350	.275	.450	3.050	YES	4P + 24S + 4P	6600333-6
	.300	.475	2.000	.250	.250	1.200	2.350	.275	.450	2.050	YES	2P + 24S + 2P	6600333-5
	.300	.425	1.700	.250	.250	.900	2.050	.275	.450	1.750	YES	2P + 16S + 2P	6600333-4
	.325	1.450	4.000	.300	.300	2.200	4.350	.300	.475	4.050	YES	5ACP + 24S + 5ACP	6600333-1

OBSOLETE

THIS DRAWING IS A CONTROLLED DOCUMENT.

DIMENSIONS: INCH	TOLERANCES UNLESS OTHERWISE SPECIFIED: 0 PLC ±. 1 PLC ±.01 2 PLC ±.01 3 PLC ±.005 4 PLC ±.002 ANGLES ±.020	OWN J. McCLINTON 23MAR2005 CHK D. TROUT 23MAR2005 APVD B. MLYNE 23MAR2005	NAME VERTICAL HEADER ASSEMBLY, W/GUIDES, PRESS FIT, TYPE PSP MULTI-BEAM XL
MATERIAL	FINISH	PRODUCT SPEC 108-1973 APPLICATION SPEC 114-13038	SIZE A100779
Customer Drawing		WEIGHT	RESTRICTED TO

SCALE 3:1 SHEET 2 OF 22 REV P7

PART NUMBER	ROWS	POWER					SIGNAL						POWER				
		P1	P2	P3	P4	P5	1	2	3	4	5	6	P6	P7	P8	P9	P10
6600333-1	D	VM	VM	VM	VM	VM	EV	EV	EV	EV	EV	EV	VM	VM	VM	VM	VM
	C						EV	EV	EV	EV	EV	EV					
	B						EV	EV	EV	EV	EV	EV					
	A						ES	ES	ES	ES	ES	ES					
5ACP+24S+5ACP		HD															

PART NUMBER	ROWS	POWER		SIGNAL						POWER		
		P1	P2	1	2	3	4	5	6	P3	P4	
6600333-5	D	VM	VM	EV	EV	EV	EV	EV	EV	EV	VM	VM
	C			EV	EV	EV	EV	EV	EV			
	B			EV	EV	EV	EV	EV	EV			
	A			ES	ES	ES	ES	ES	ES			
2P+24S+2P		HD										

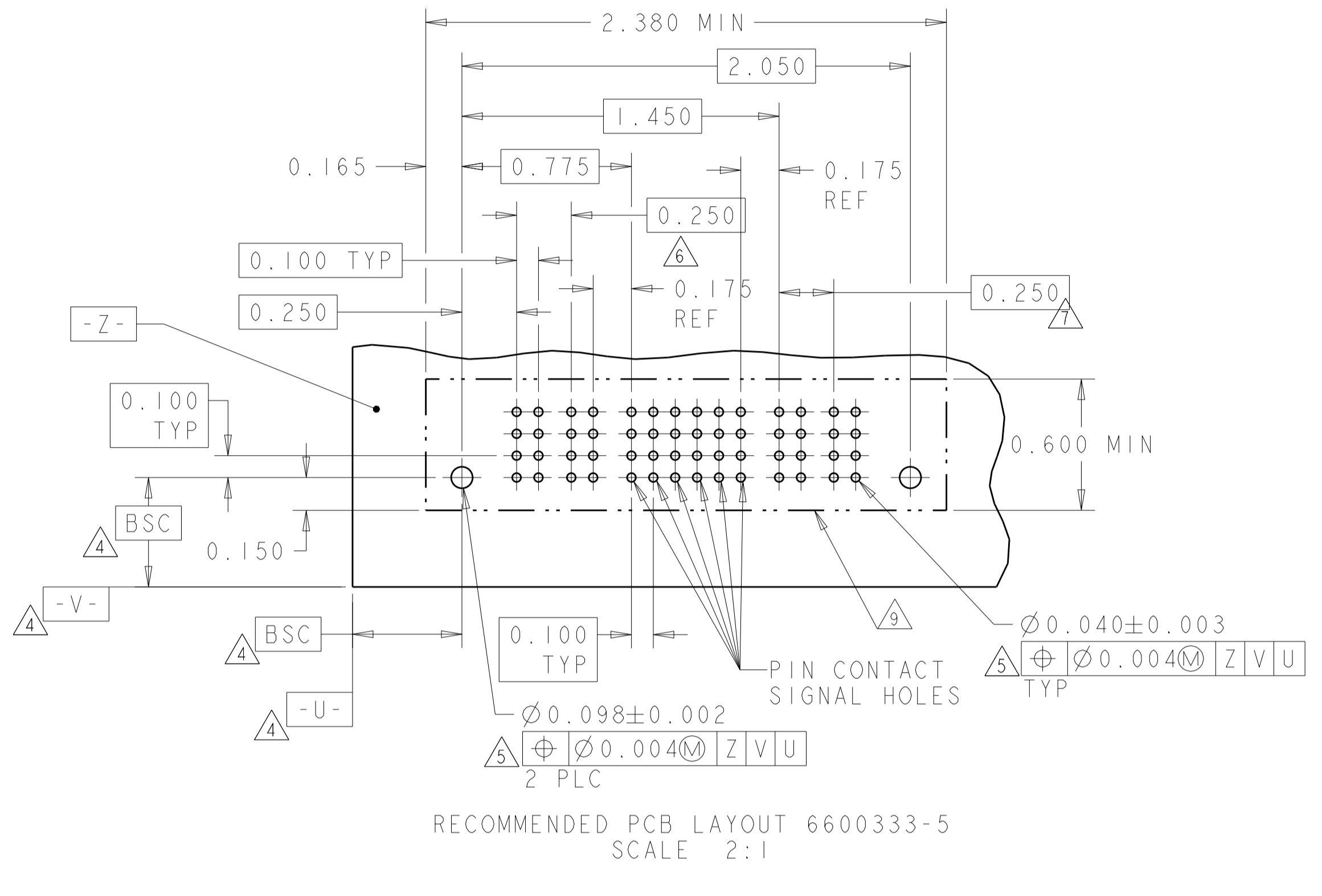
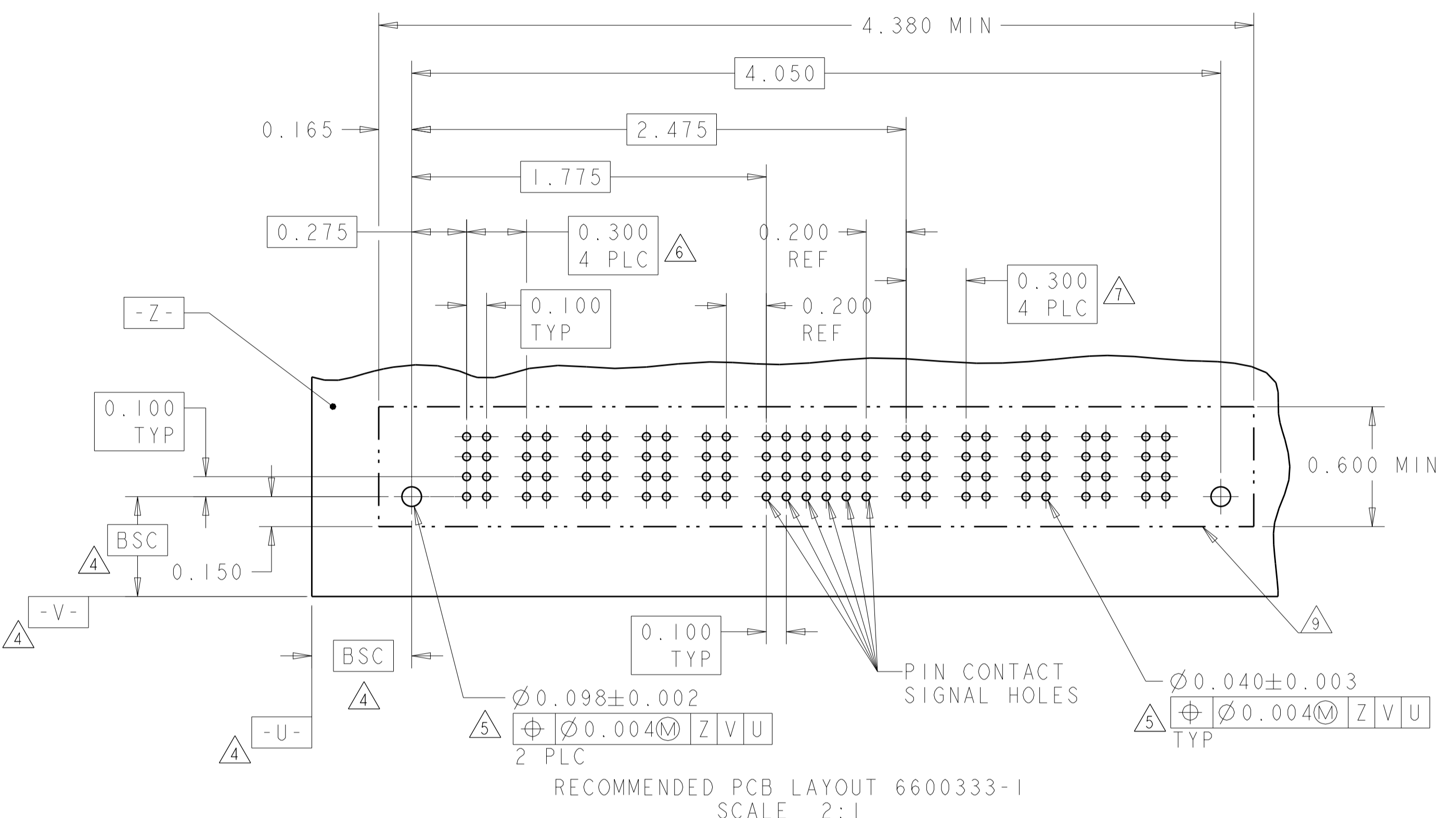

PART NUMBER	ROWS	POWER		SIGNAL				POWER	
		P1	P2	1	2	3	4	P3	P4
6600333-4	D	VM	VM	EV	EV	EV	EV	VM	VM
	C			EV	EV	EV	EV		
	B			EV	EV	EV	EV		
	A			EV	EV	EV	EV		
2P+16S+2P		HD							

PART NUMBER	ROWS	POWER				SIGNAL						POWER			
		P1	P2	P3	P4	1	2	3	4	5	6	P5	P6	P7	P8
6600333-6	D	VM	VM	VM	VM	ES	ES	ES	ES	EV	ES	VM	VM	VM	VM
	C					ES	ES	ES	ES	ES					
	B					ES	ES	ES	ES	EV	ES				
	A					ES	ES	EV	ES	EV	ES				
4P+24S+4P		HD													

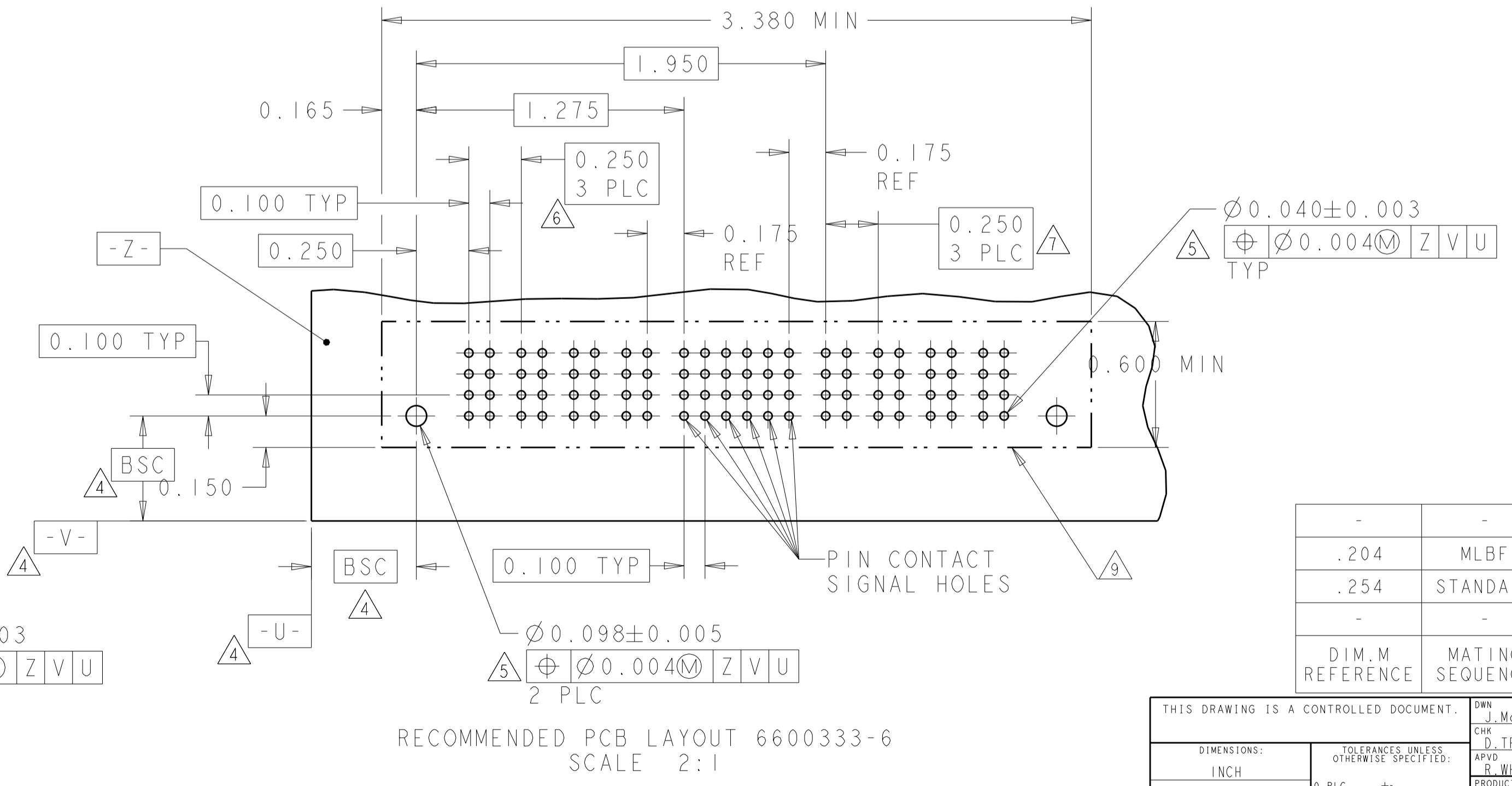
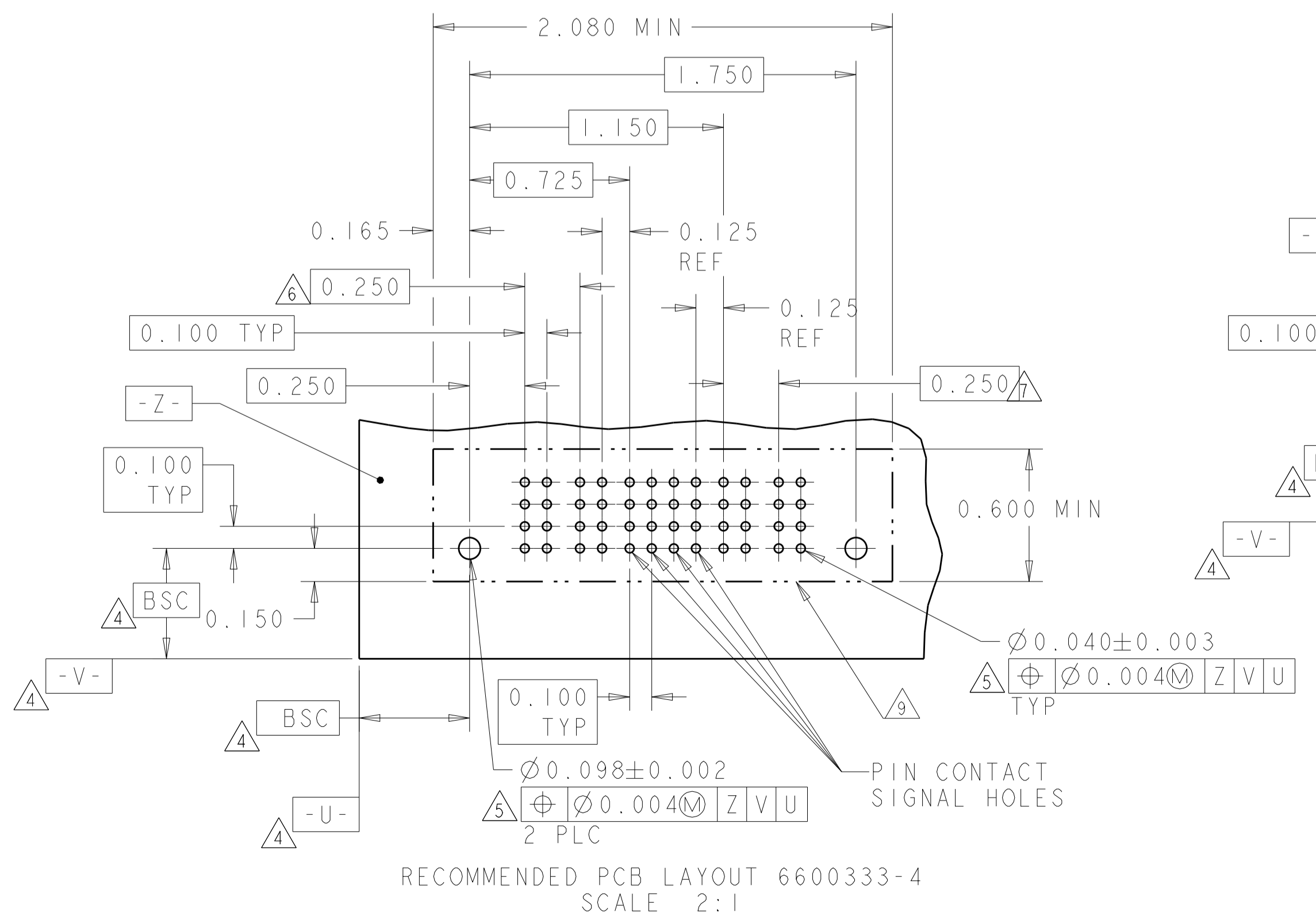

DIM. M REFERENCE	MATING SEQUENCE	DESCRIPTION	IDENTIFIER
-	-	RETENTION CLIP	HD
.204	MLBF	SIGNAL CONTACT .165 TAIL LENGTH	ES
.254	STANDARD	SIGNAL CONTACT .165 TAIL LENGTH	EV
-	-	POWER CONTACT .165 TAIL LENGTH	VM

THIS DRAWING IS A CONTROLLED DOCUMENT.

DIMENSIONS: INCH	TOLERANCES UNLESS OTHERWISE SPECIFIED:	OWN: J. McCLINTON 23MAR2005	CHK: D. TROUT 23MAR2005	APVD: B. WILBYNE 23MAR2005
0 PLC ±.01	1 PLC ±.01	PRODUCT SPEC		
2 PLC ±.01	3 PLC ±.005	108-1973		
4 PLC ±.002	ANGLES ±.002	APPLICATION SPEC		
FINISH	FINISH	114-13038		
MATERIAL	FINISH	WEIGHT		
		Customer Drawing		

SCALE 3:1 SHEET 3 OF 22 REV P7

TE Connectivity
 VERTICAL HEADER ASSEMBLY, W/GUIDES, PRESS FIT, TYPE PSP MULTI-BEAM XL

SIZE: A100779 CAGE CODE: 6600333

PART NUMBER	ROWS	POWER			SIGNAL				POWER		
		P1	P2	P3	1	2	3	4	P4	P5	P6
6600333-7	D	VM	VM	VM	EV	EV	EV	EV	VM	VM	VM
	C				ES	ES	ES	ES			
	B				ES	ES	ES	ES			
	A				EV	EV	EV	EV			
3P+16S+3P		HD									HD

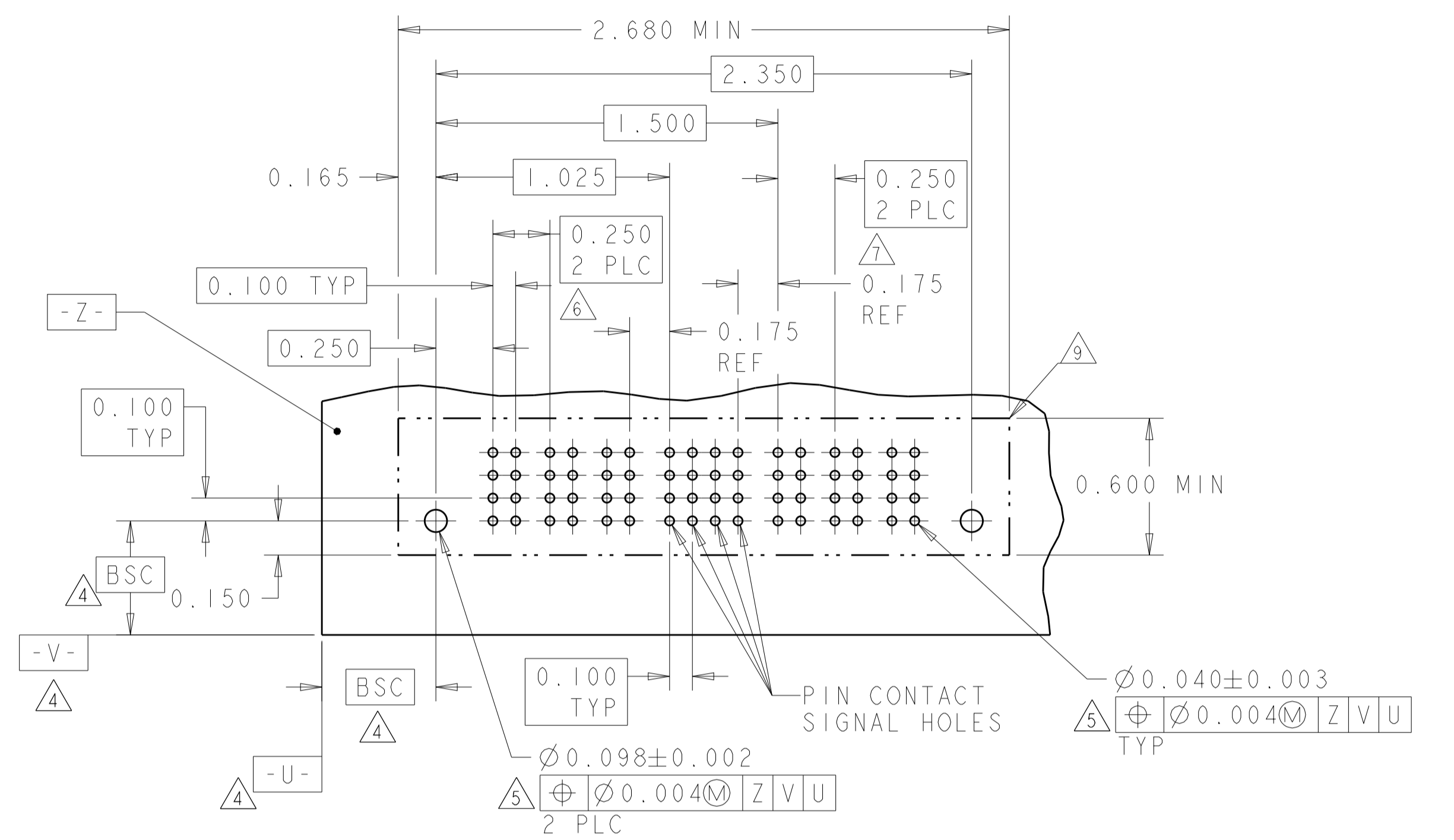

RECOMMENDED PCB LAYOUT 6600333-7
 SCALE 2:1

PART NUMBER	ROWS	POWER		SIGNAL																		POWER						
		P1	P2	1	2	3	4	5	6	7	8	9	10	11	12	13	14	15	16	17	18	19	20	21	22	P3		
6600333-8	D	VM	VM	EV	EV	EV	EV	EV	EV	EV	EV	EV	EV	EV	EV	EV	EV	EV	EV	EV	EV	EV	EV	EV	EV	EV	VM	
	C			EV	EV	EV	EV	EV	EV	EV	EV	EV	EV	EV	EV	EV	EV	EV	EV	EV	EV	EV	EV	EV	EV	EV		
	B			EV	EV	EV	EV	EV	EV	EV	EV	EV	EV	EV	EV	EV	EV	EV	EV	EV	EV	EV	EV	EV	EV	EV		EV
	A			EV	EV	EV	EV	EV	EV	EV	EV	EV	EV	EV	EV	EV	EV	EV	EV	EV	EV	EV	EV	EV	EV	EV		EV
2P+88S+1P		HD																								HD		

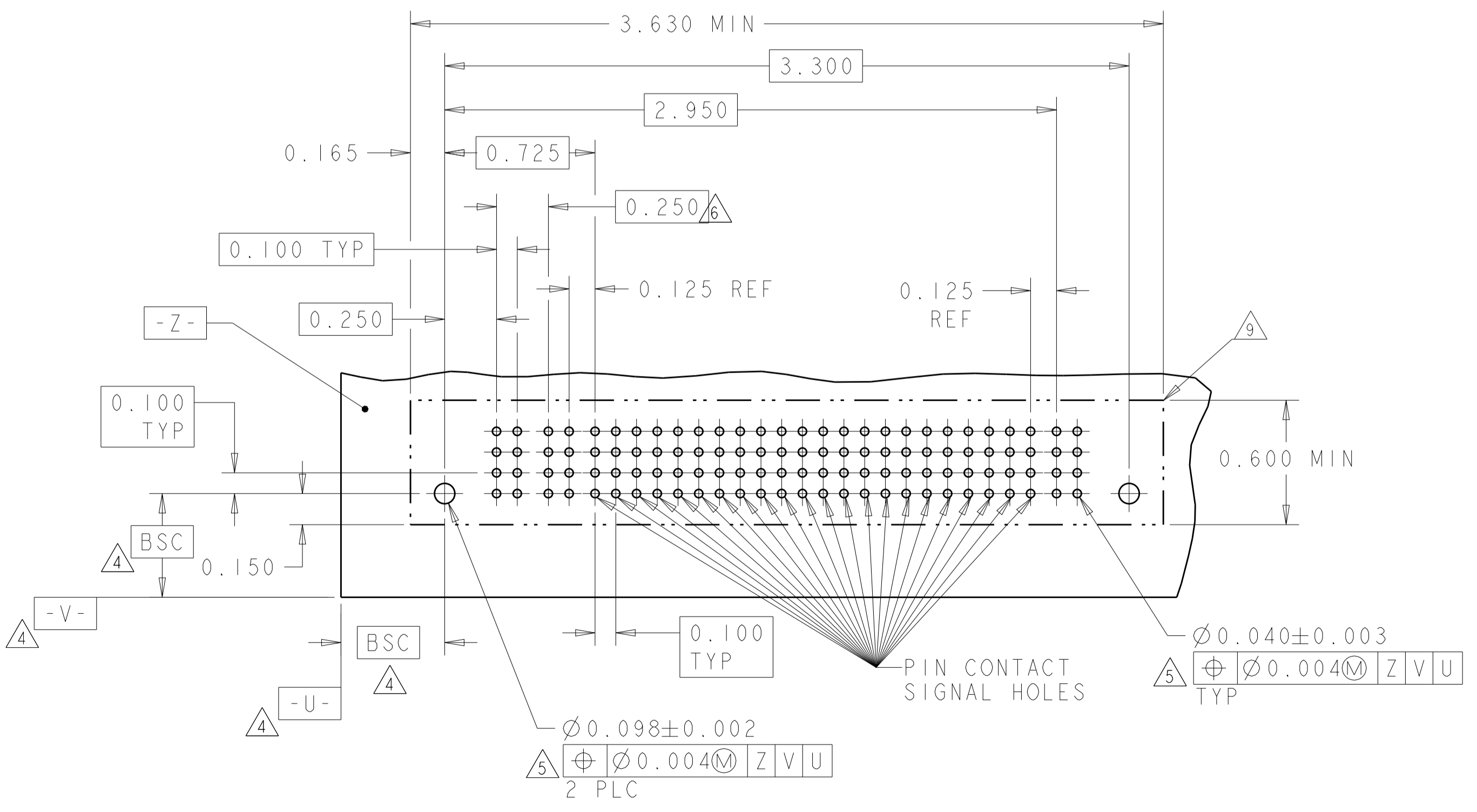

RECOMMENDED PCB LAYOUT 6600333-8
 SCALE 2:1

PART NUMBER	ROWS	POWER		SIGNAL				POWER
		P1	P2	1	2	3	4	P2
6600333-9	D	VM	VM	ES	EV	ES	EV	VM
	C			EV	EV	EV	EV	
	B			ES	EV	ES	EV	
	A			ES	EV	ES	EV	
1P+16S+1P		HD						HD

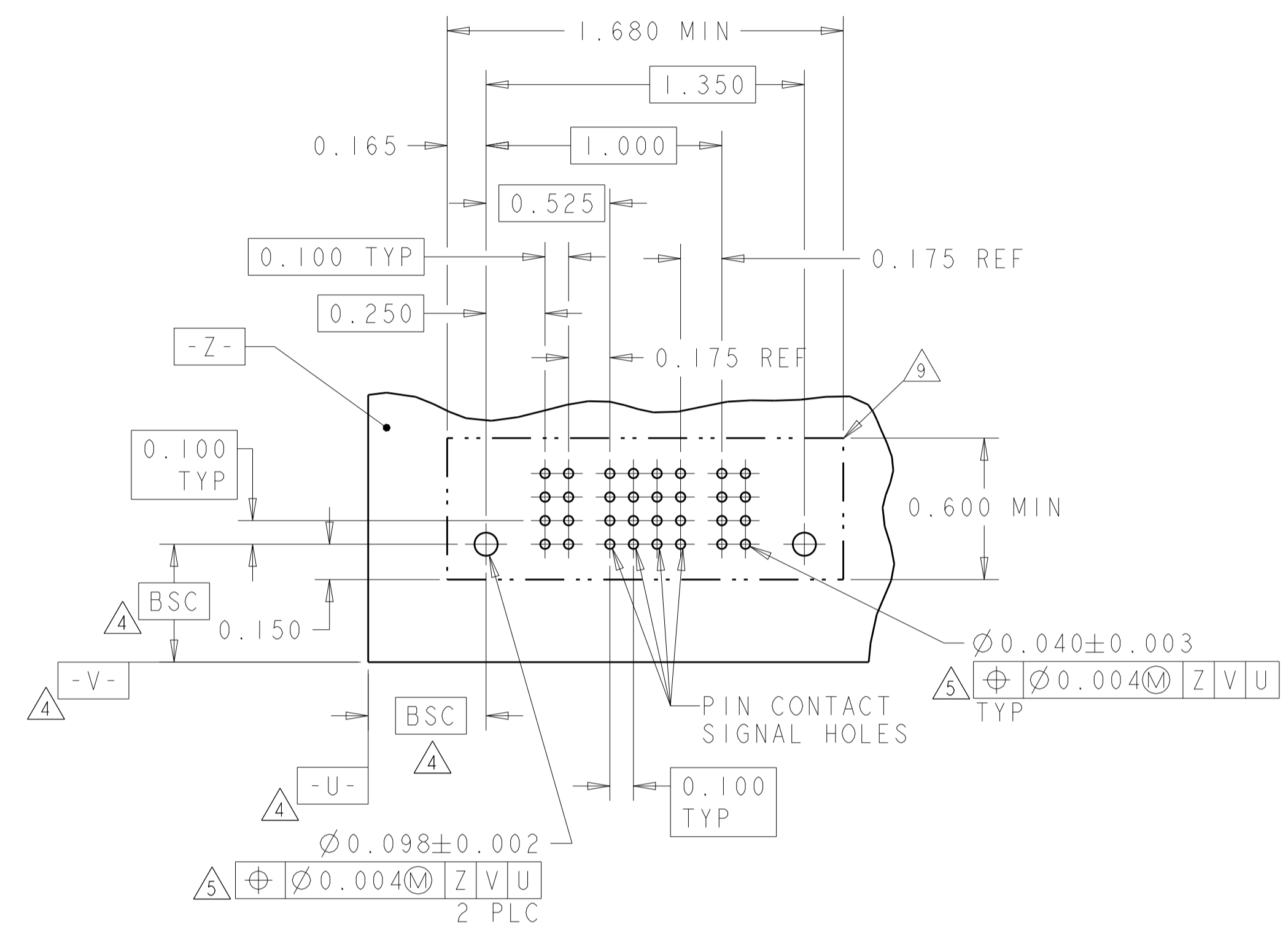

RECOMMENDED PCB LAYOUT 6600333-9
 SCALE 2:1

PART NUMBER	ROWS	POWER		SIGNAL				POWER
		P1	P2	1	2	3	4	P2
3-6600333-0	D	VM	VM	ES	EV	EV	ES	VM
	C			EV	EV	EV	EV	
	B			EV	EV	EV	EV	
	A			EV	EV	EV	EV	
IP+16S+1P		HD						HD

THE PCB LAYOUT OF 3-6600333-0 IS SAME AS 6600333-9

THIS DRAWING IS A CONTROLLED DOCUMENT. DWN J. McCLINTON 23MAR2005
 CHK D. TROUT 23MAR2005
 APVD B. MLYNE 23MAR2005

DIMENSIONS: INCH TOLERANCES UNLESS OTHERWISE SPECIFIED:
 0 PLC ±.01
 1 PLC ±.01
 2 PLC ±.01
 3 PLC ±.005
 4 PLC ±.002
 ANGLES ±.020

MATERIAL: FINISH: WEIGHT: SIZE: CAGE CODE: DRAWING NO: RESTRICTED TO:
 Customer Drawing SCALE 3:1 SHEET 4 OF 22 REV P7

STE TE Connectivity
 NAME VERTICAL HEADER ASSEMBLY, W/GUIDES, PRESS FIT, TYPE PSP MULTI-BEAM XL
 PRODUCT SPEC 108-1973
 APPLICATION SPEC 114-13038
 A100779C=6600333

PART NUMBER	ROWS	POWER		SIGNAL				POWER	
		P1	P2	1	2	3	4	P3	P4
I-6600333-0	D	VM	VM	EV	EV	EV	EV	VM	VM
	C			ES	ES	ES	ES		
	B			ES	ES	ES	ES		
	A			EV	EV	EV	EV		
2P+16S+2P		HD						HD	

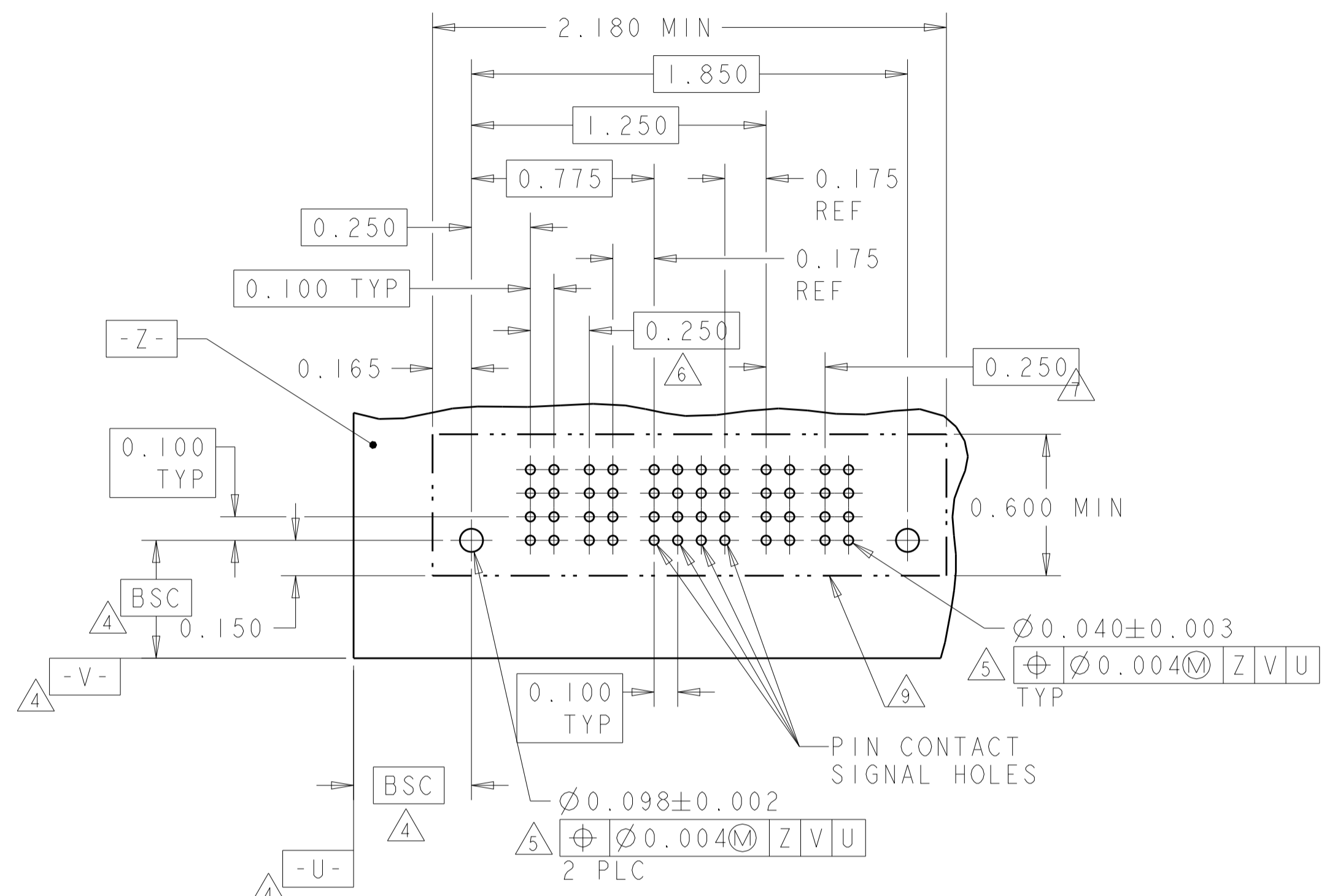

RECOMMENDED PCB LAYOUT I-6600333-0
SCALE 2:1

PART NUMBER	ROWS	POWER			SIGNAL						POWER		
		P1	P2	P3	1	2	3	4	5	6	P4	P5	P6
I-6600333-1	D	VM	VM	VM	EV	EV	EV	EV	EV	EV	VM	VM	VM
	C				EV	EV	EV	EV	EV	EV			
	B				EV	EV	EV	EV	EV	EV			
	A				EV	EV	EV	EV	EV	EV			
3ACP+24S+3ACP		HD								HD			

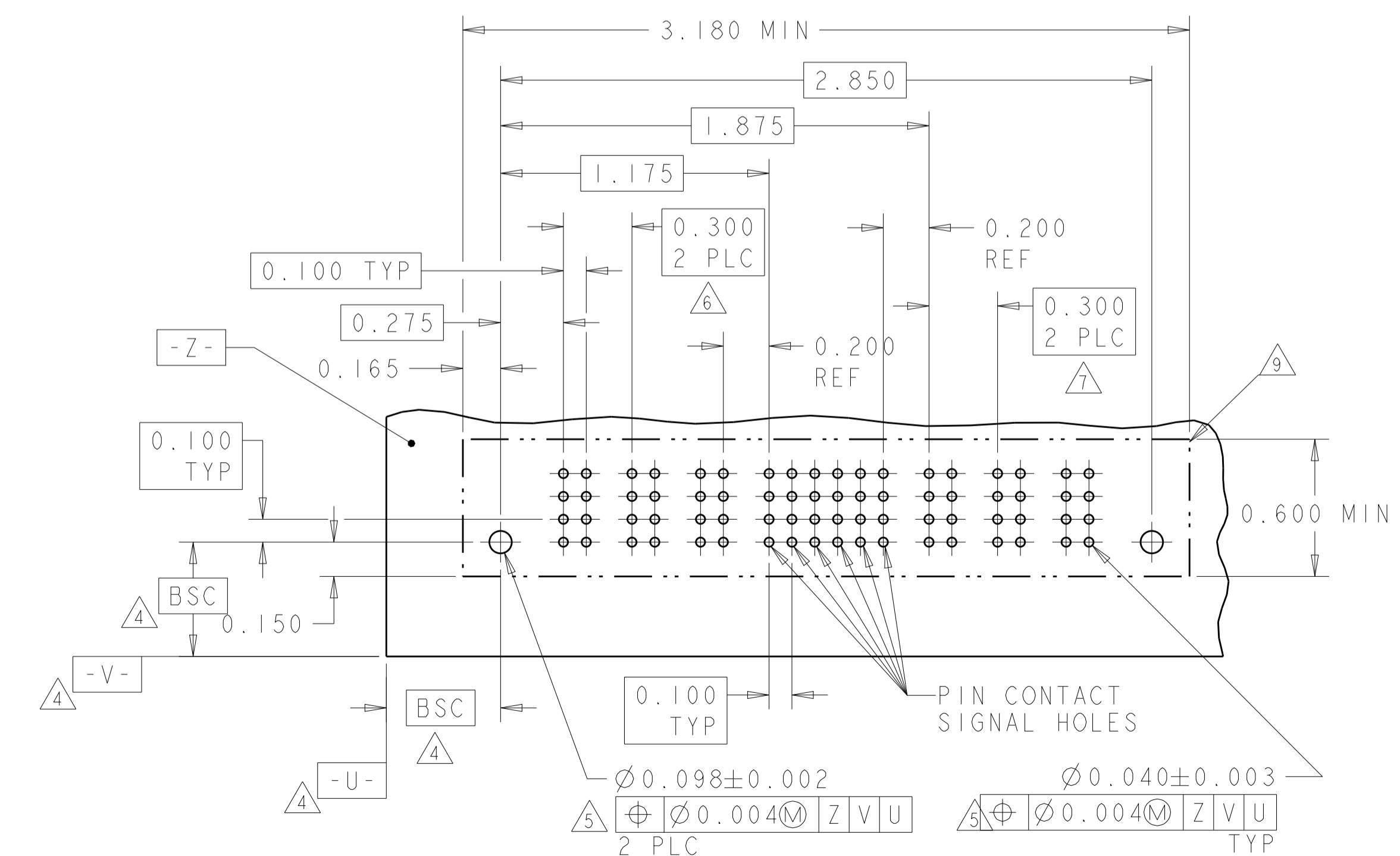

RECOMMENDED PCB LAYOUT I-6600333-1
SCALE 2:1

PART NUMBER	ROWS	POWER		SIGNAL						POWER	
		P1	P2	1	2	3	4	5	6	P3	P4
I-6600333-2	D	VM	VM	EV	EV	EV	EV	EV	EV	VM	VM
	C			EV	EV	EV	EV	EV	EV		
	B			EV	EV	EV	EV	EV	EV		
	A			EV	EV	EV	EV	EV	EV		
2P+24S+2P		HD								HD	

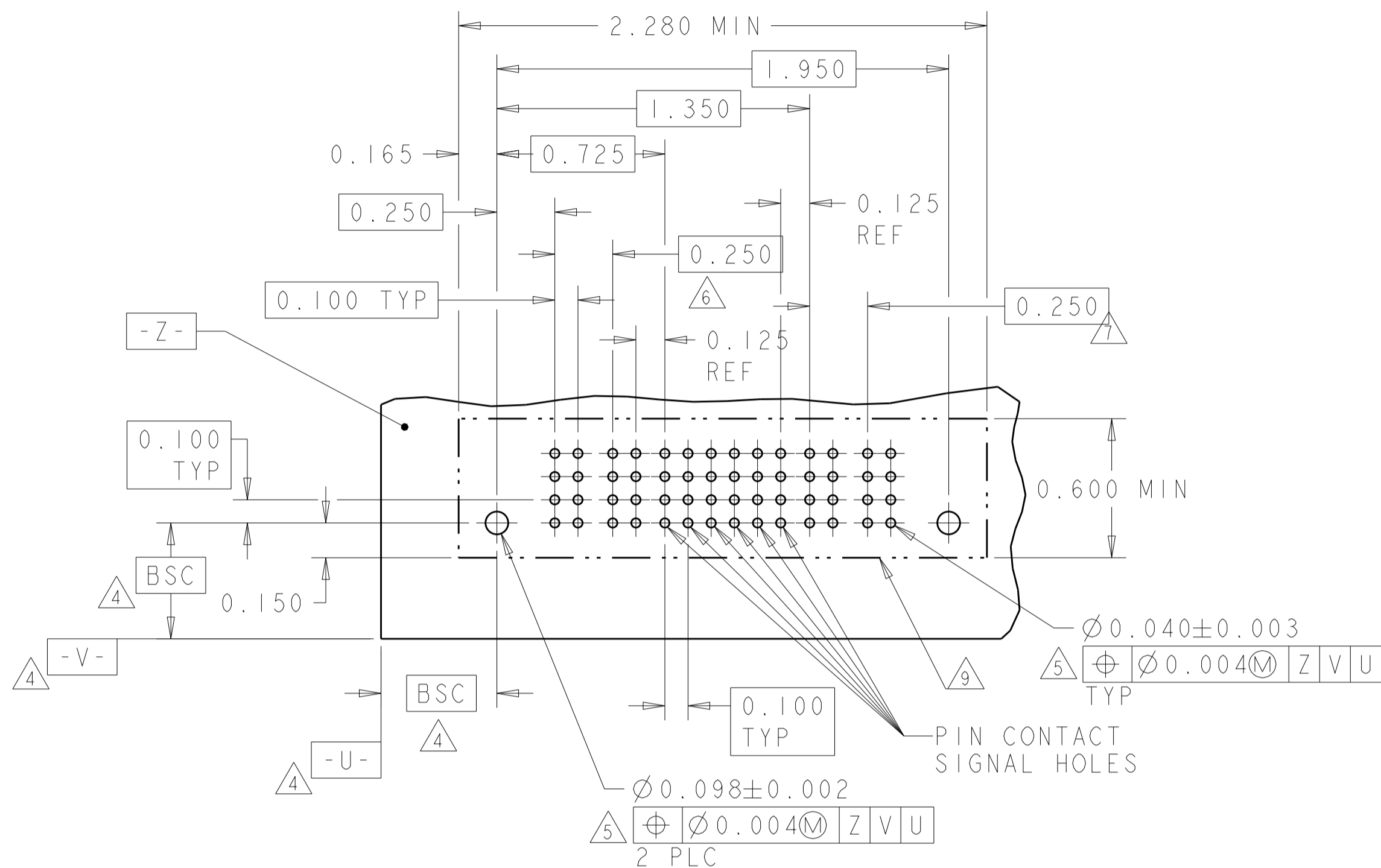

RECOMMENDED PCB LAYOUT I-6600333-2
SCALE 2:1

PART NUMBER	ROWS	POWER						SIGNAL						POWER							
		P1	P2	P3	P4	P5	P6	1	2	3	4	5	6	P7	P8	P9	P10	P11	P12		
I-6600333-3	D	VM	VM	VM	VM	VM	VM	EV	EV	EV	EV	EV	EV	VM	VM	VM	VM	VM	VM		
	C							EV	EV	EV	EV	EV	EV								
	B							EV	EV	EV	EV	EV	EV								
	A							EV	EV	EV	EV	EV	EV								
6P+24S+6P		HD														HD					

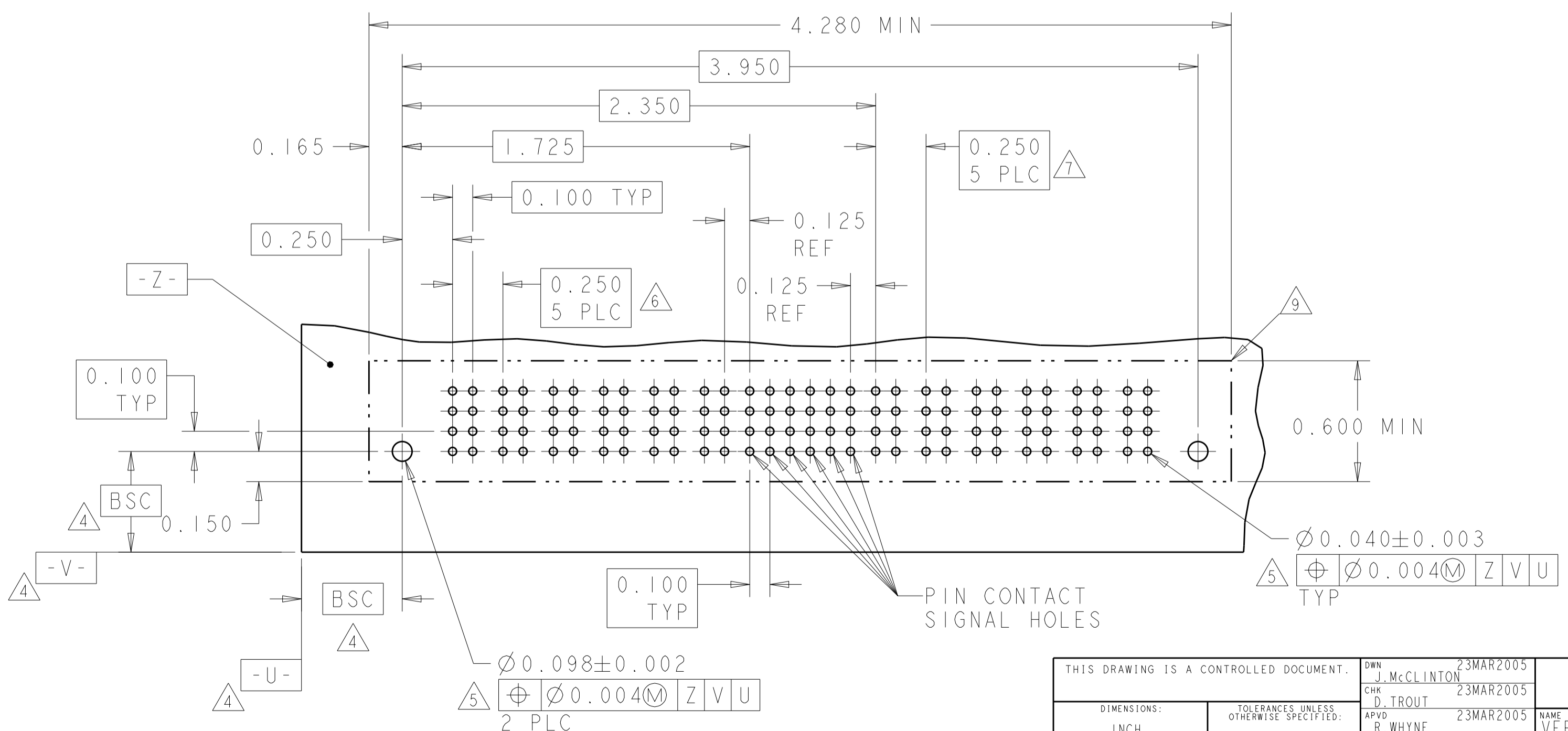

RECOMMENDED PCB LAYOUT I-6600333-3
SCALE 2:1

LOC	DIST	REVISIONS			
ES	00	REV	DATE	BY	APPV
		1			
		2			

THIS DRAWING IS A CONTROLLED DOCUMENT.

DIMENSIONS: INCH	TOLERANCES UNLESS OTHERWISE SPECIFIED: 0 PLC ±.01 1 PLC ±.01 2 PLC ±.01 3 PLC ±.005 4 PLC ±.002 ANGLES ±.02	OWN: J. McCLINTON 23MAR2005 CHK: D. TROUT 23MAR2005 APPV: P. MLYNE 23MAR2005	NAME: VERTICAL HEADER ASSEMBLY, W/GUIDES, PRESS FIT, TYPE PSP MULTI-BEAM XL SIZE: CAGE CODE DRAWING NO: 114-13038 RESTRICTED TO: A100779
MATERIAL:	FINISH:	WEIGHT:	Customer Drawing

SCALE 3:1 SHEET 5 OF 22 REV P7

PART NUMBER	ROWS	POWER				SIGNAL								POWER			
		P1	P2	P3	P4	1	2	3	4	5	6	7	8	P5	P6	P7	P8
1-6600333-4	D	VM	VM	VM	VM	EV	EV	EV	EV	EV	EV	EV	EV	VM	VM	VM	VM
	C					EV	EV	EV	EV	EV	EV	EV					
	B					EV	EV	EV	EV	EV	EV	EV					
	A					EV	EV	EV	EV	EV	EV	EV					
4P+32S+4P		HD															

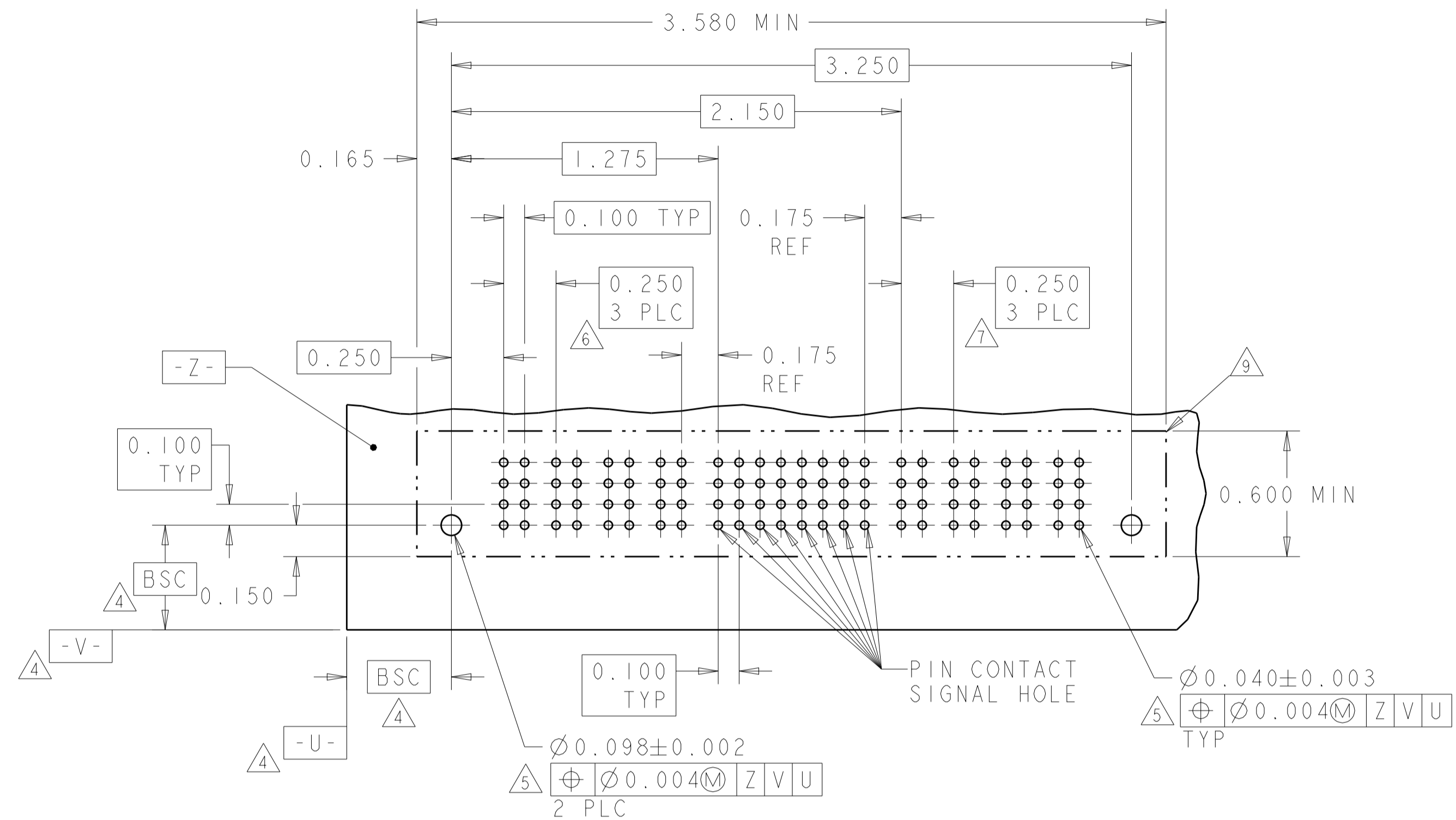

RECOMMENDED PCB LAYOUT 1-6600333-4
 SCALE 2:1

PART NUMBER	ROWS	POWER					SIGNAL						POWER						
		P1	P2	P3	P4	P5	P6	1	2	3	4	5	6	P7	P8	P9	P10	P11	P12
1-6600333-5	D	VM	VM	VM	VM	VM	VM	EV	EV	EV	EV	EV	VM	VM	VM	VM	VM	VM	VM
	C							EV	EV	EV	EV	EV							
	B							EV	EV	EV	EV	EV							
	A							EV	EV	EV	EV	ES							
6P+24S+6P		HD																	

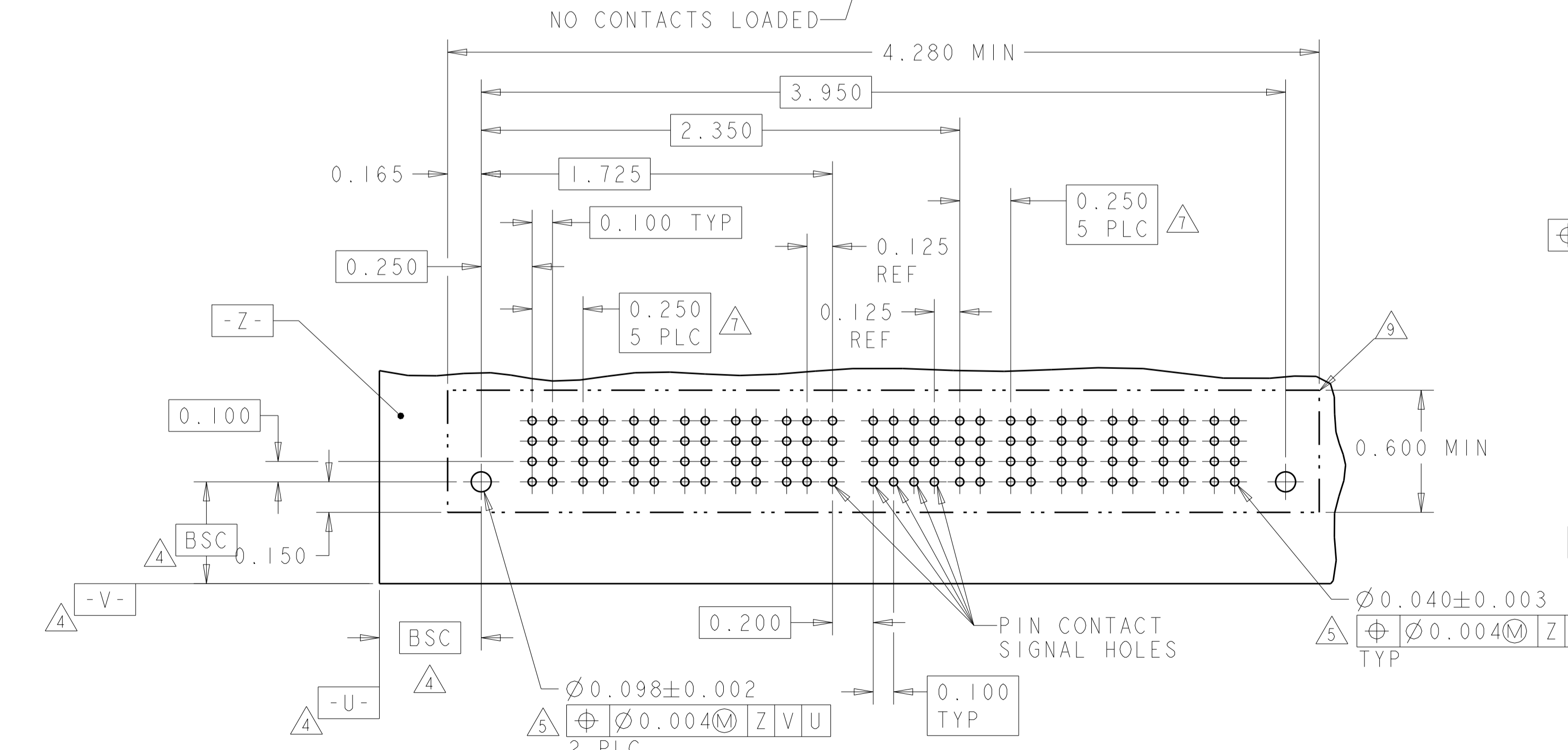

RECOMMENDED PCB LAYOUT 1-6600333-5
 SCALE 2:1

PART NUMBER	ROWS	POWER		SIGNAL						POWER		
		P1	P2	1	2	3	4	5	6	P3	P4	
1-6600333-6	D	VM	VM	ES	ES	ES	ES	ES	ES	EV	VM	VM
	C			ES	EV	EV	EV	EV	ES			
	B			ES	ES	ES	ES	ES	ES			
	A			ES	ES	ES	ES	EV	ES			
2P+24S+2P		HD										

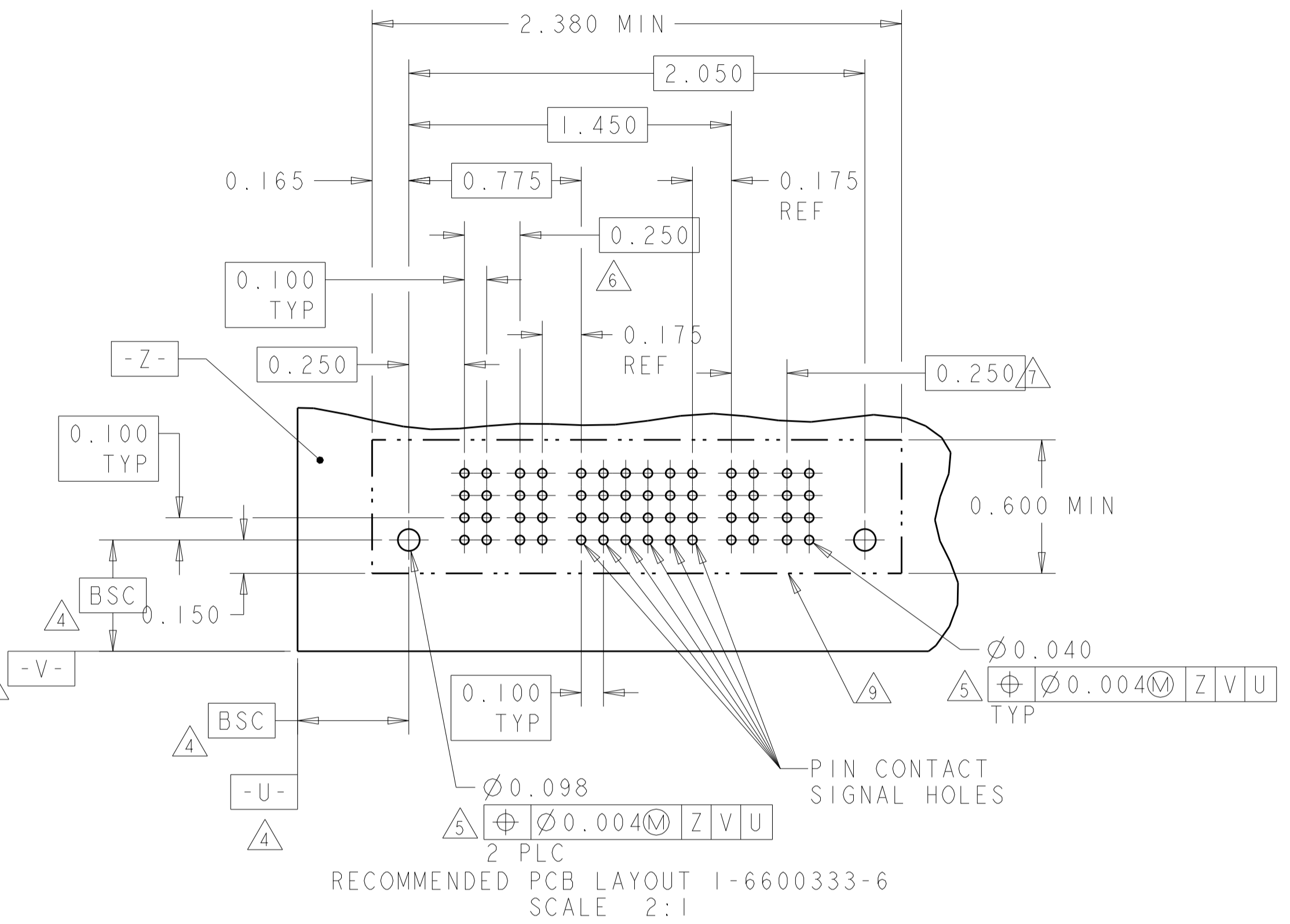

RECOMMENDED PCB LAYOUT 1-6600333-6
 SCALE 2:1

PART NUMBER	ROWS	POWER						SIGNAL						POWER							
		P1	P2	P3	P4	P5	P6	1	2	3	4	5	6	P7	P8	P9	P10	P11	P12	P13	P14
2-6600333-1	D	VM	VM	VM	VM	VM	VM	EV	EV	EV	EV	EV	EV	VM	VM	VM	VM	VM	VM	VM	
	C							EV	EV	EV	EV	EV									
	B							EV	EV	EV	EV	EV									
	A							EV	EV	EV	EV	EV									
6ACP + 24S + 8P		HD																			

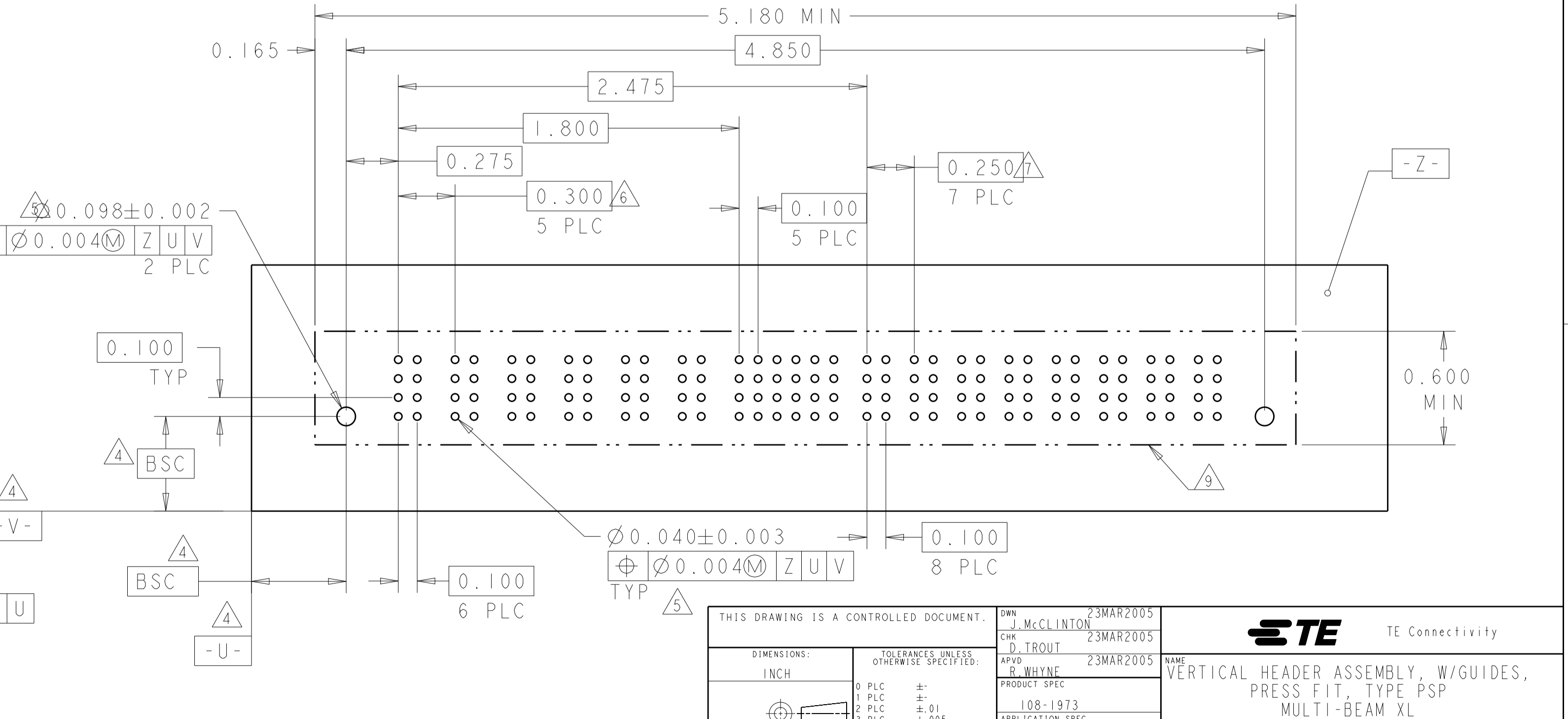

THIS DRAWING IS A CONTROLLED DOCUMENT.

DIMENSIONS: INCH
 TOLERANCES UNLESS OTHERWISE SPECIFIED:
 0 PLC ±.
 1 PLC ±.01
 2 PLC ±.01
 3 PLC ±.005
 4 PLC ±.002
 ANGLES ±0.020
 MATERIAL: .
 FINISH: .

DWG: J. McCLINTON 23MAR2005
 CHK: D. TROUT 23MAR2005
 APVD: B. MLYNE 23MAR2005
 PRODUCT SPEC
 108-1973
 APPLICATION SPEC
 114-13038
 WEIGHT: .
 Customer Drawing

STE TE Connectivity
 NAME: VERTICAL HEADER ASSEMBLY, W/GUIDES, PRESS FIT, TYPE PSP MULTI-BEAM XL
 SIZE: A1
 CAGE CODE: 6600333
 DRAWING NO: 100779
 SCALE: 3:1
 SHEET: 6 OF 22
 REV: P7

LOC	DIST	REV	DATE	BY	APPV
ES	00				

REV	DATE	DESCRIPTION
1		SEE SHEET 1

LOC	DIST	REV	DATE	BY	APPV
ES	00				
REVISIONS					
DESCRIPTION			DATE	BY	APPV
SEE SHEET 1					

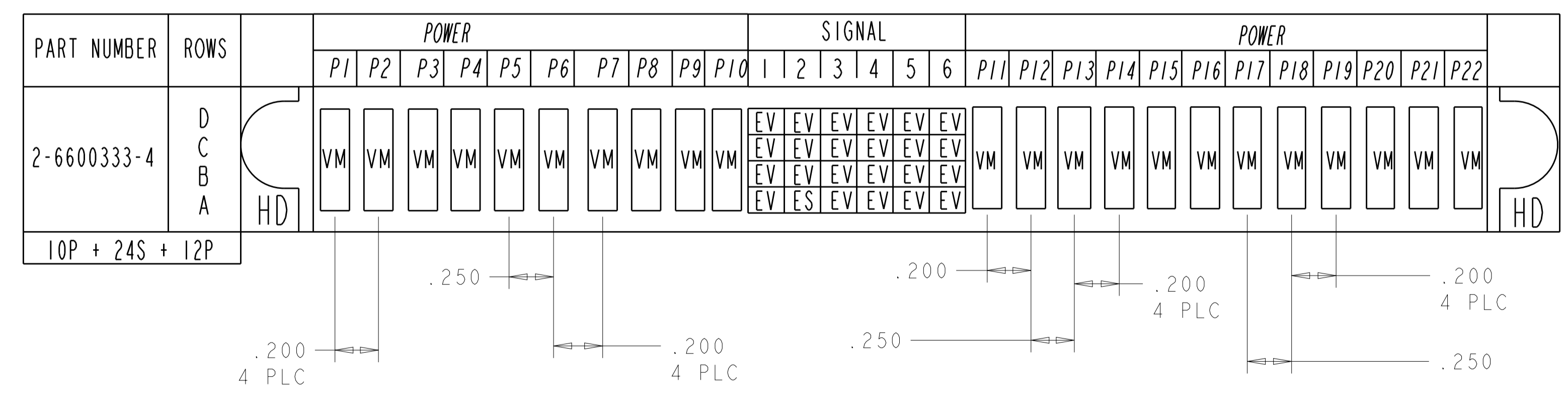
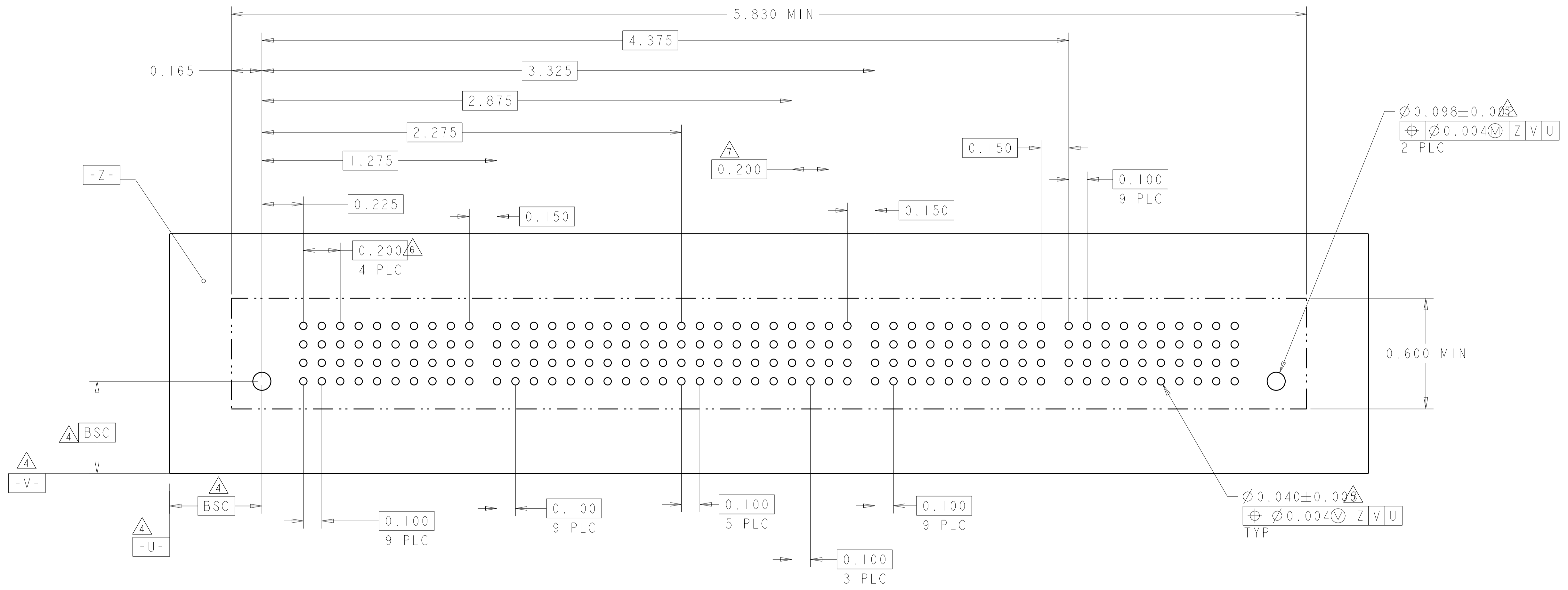
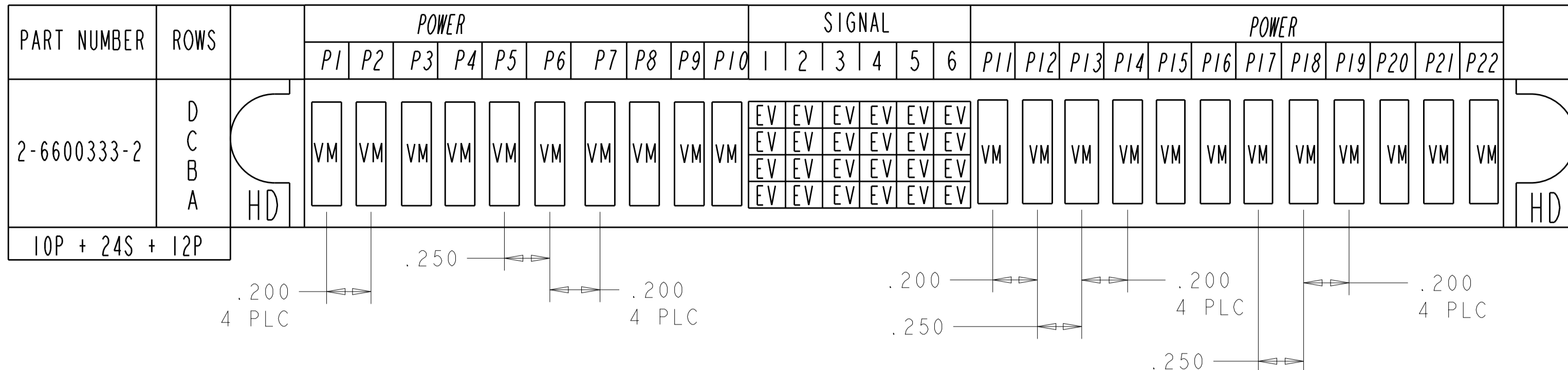

THE PART NUMBER 2-6600333-4 PCB LAYOUT IS SAME AS 2-6600333-2

THIS DRAWING IS A CONTROLLED DOCUMENT.		OWN: J. McCLINTON 23MAR2005	 TE Connectivity										
DIMENSIONS: INCH		CHK: D. TROUT 23MAR2005											
TOLERANCES UNLESS OTHERWISE SPECIFIED:		APV: B. WHYNE 23MAR2005	NAME: VERTICAL HEADER ASSEMBLY, W/GUIDES, PRESS FIT, TYPE PSP MULTI-BEAM XL										
<table border="1"> <tr> <td>0 PLC</td><td>± .01</td></tr> <tr> <td>1 PLC</td><td>± .01</td></tr> <tr> <td>3 PLC</td><td>± .005</td></tr> <tr> <td>4 PLC</td><td>± .002</td></tr> <tr> <td>ANGLES</td><td>± .020</td></tr> </table>		0 PLC	± .01	1 PLC	± .01	3 PLC	± .005	4 PLC	± .002	ANGLES	± .020	PRODUCT SPEC: 108-1973	SIZE: A1
0 PLC	± .01												
1 PLC	± .01												
3 PLC	± .005												
4 PLC	± .002												
ANGLES	± .020												
MATERIAL: -		APPLICATION SPEC: 114-13038	CAGE CODE: 6600333										
FINISH: -		WEIGHT: -	RESTRICTED TO: -										
Customer Drawing		SCALE: 3:1	SHEET 7 OF 22 REV: P7										

LOC		DIST		REVISIONS			
ES	00	P	LTN	DESCRIPTION	DATE	DMN	APVD
		-		SEE SHEET 1	-	-	-

PART NUMBER	ROWS	POWER				SIGNAL				POWER		
		P1	P2	P3	P4	1	2	3	4	P5	P6	P7
2-6600333-5	D	VM	VM	VM	VM	EV	EV	EV	EV	VM	VM	VM
	C					EV	EV	EV	EV			
	B					EV	EV	EV	EV			
	A					ES	EV	EV	EV			
4P+16S+3P		HD										HD

PART NUMBER	ROWS	POWER			SIGNAL						POWER		
		P1	P2	P3	1	2	3	4	5	6	P4	P5	P6
2-6600333-6	D	VM	VM	VM	EV	EV	EV	EV	EV	EV	VM	VM	VM
	C				EV	EV	EV	EV	EV				
	B				EV	EV	EV	EV	EV				
	A				ES	EV	EV	EV	EV				
3P+24S+3P		HD											HD

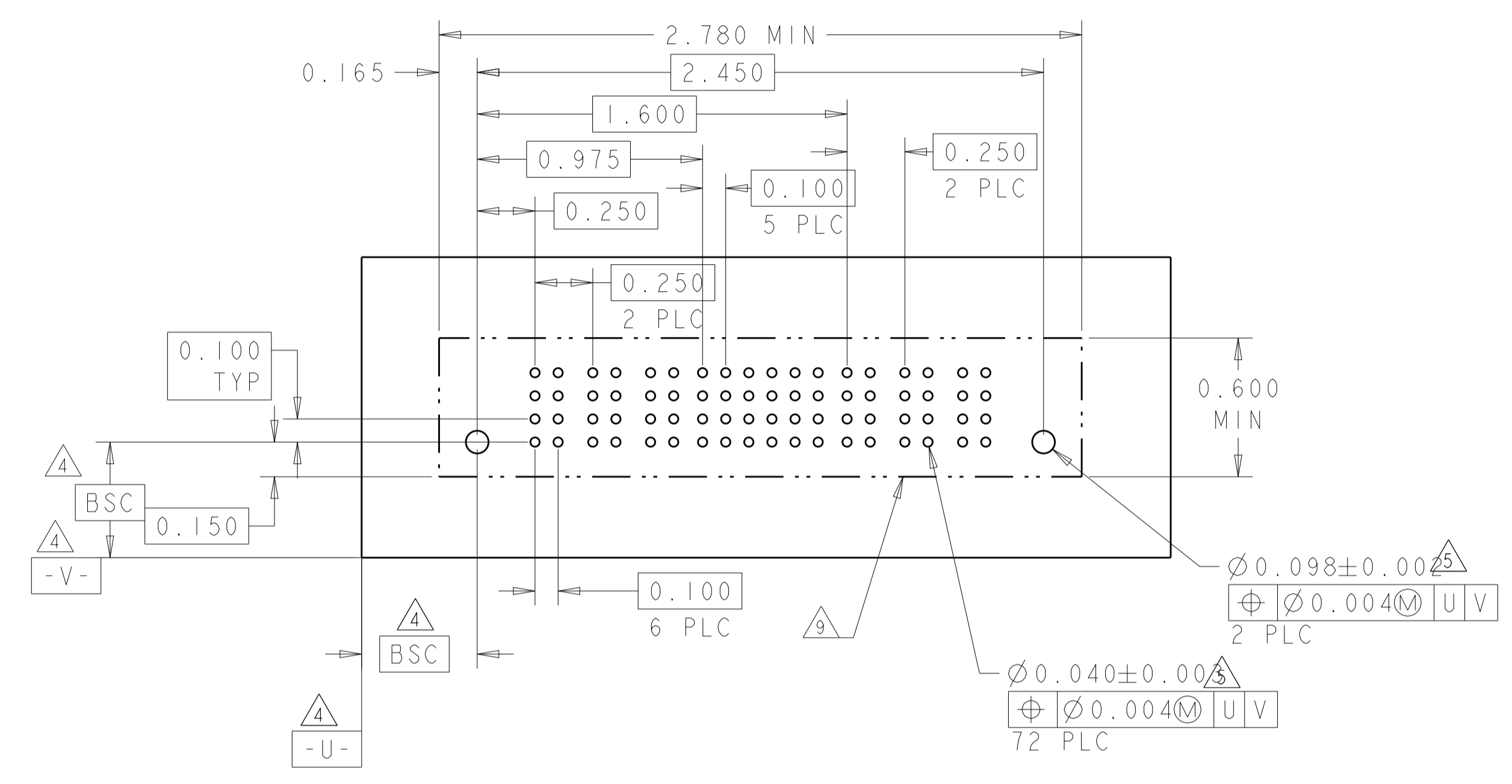
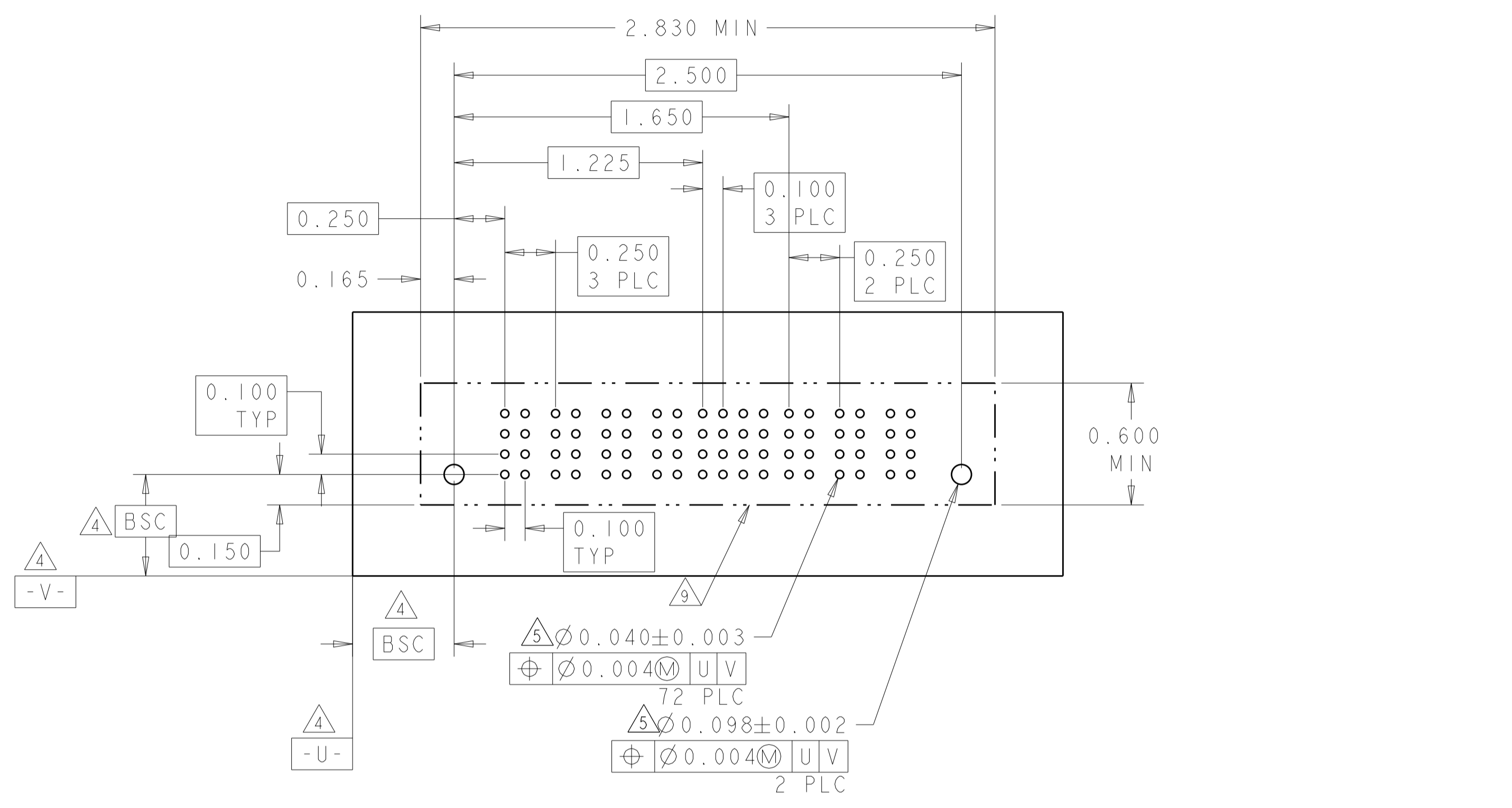

PART NUMBER	ROWS	POWER				SIGNAL						POWER					
		P1	P2	P3	P4	1	2	3	4	5	6	P5	P6	P7	P8	P9	
2-6600333-7	D	VM	VM	VM	VM	ES	EV	ES	EV	ES	EV	VM	VM	VM	VM	VM	
	C					EV	EV	EV	ES	EV							
	B					EV	ES	EV	EV	EV							
	A					ES	ES	EV	EV	ES							
4P+24S+5P		HD															HD

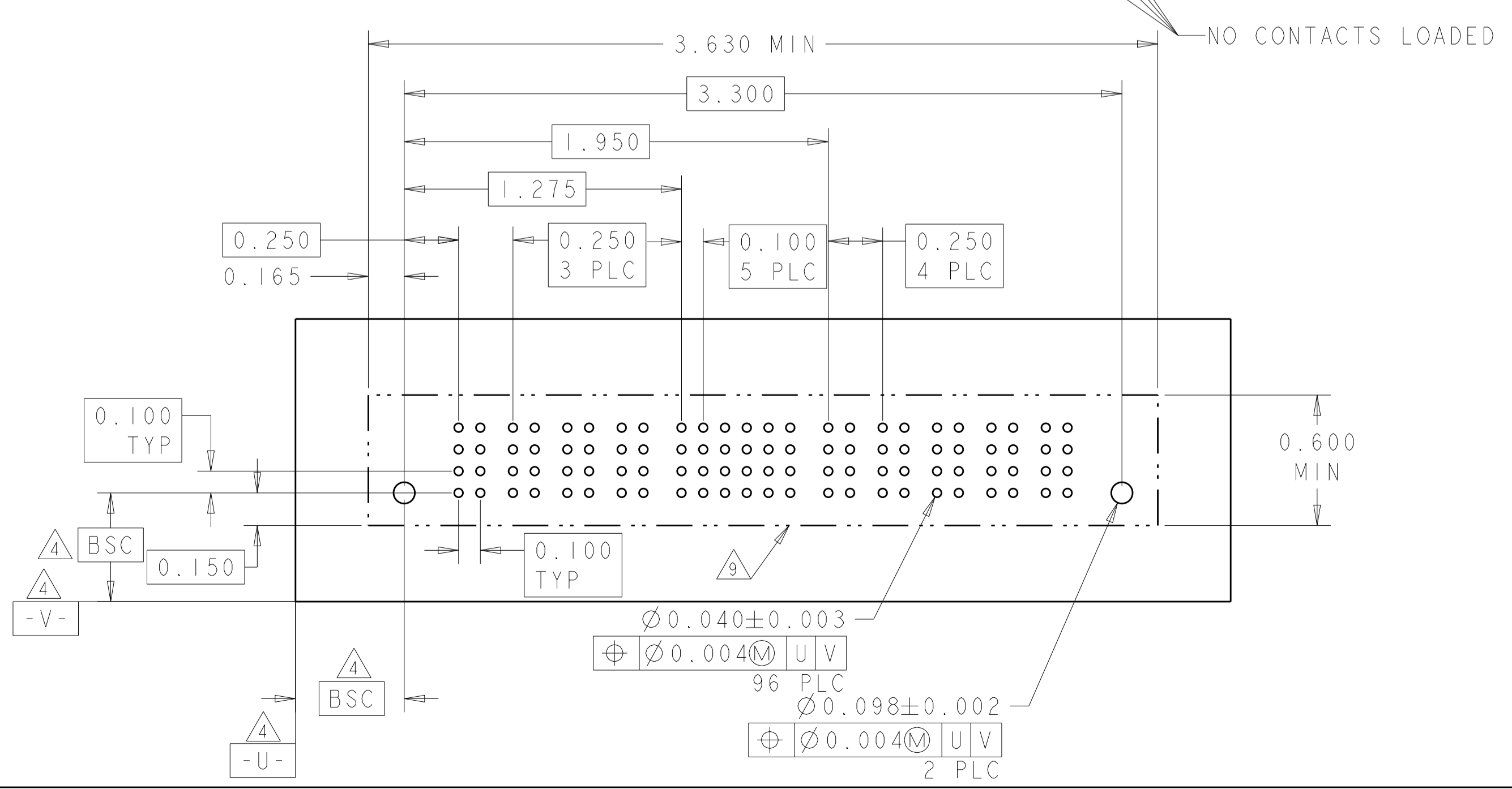

THIS DRAWING IS A CONTROLLED DOCUMENT.

DIMENSIONS: INCH	TOLERANCES UNLESS OTHERWISE SPECIFIED:	DMN: J. McCLINTON 23MAR2005	CHK: D. TROUT 23MAR2005	APVD: B. WHYNE 23MAR2005
	0 PLC ±.01	PRODUCT SPEC	NAME: VERTICAL HEADER ASSEMBLY, W/GUIDES, PRESS FIT, TYPE PSP MULTI-BEAM XL	
	1 PLC ±.01	APPLICATION SPEC	SIZE: A100779	DRAWING NO: C=6600333
MATERIAL: -	FINISH: -	WEIGHT: -	SCALE: 3:1	SHEET 9 OF 22

Customer Drawing

LOC	DIST	REVISIONS			
P	LTN	DESCRIPTION	DATE	DMN	APVD
ES	00	SEE SHEET 1	-	-	-

PART NUMBER	ROWS	POWER				SIGNAL				POWER		
		P1	P2	P3	P4	1	2	3	4	P5	P6	P7
2-6600333-8	D	VM	VM	VM	VM	ES	ES	EV	EV	VM	VM	VM
	C					ES	EV	EV	EV			
	B					ES	EV	EV	EV			
	A					EV	EV	ES	ES			
4P+16S+3P												HD

PART NUMBER	ROWS	POWER		SIGNAL								POWER			
		P1	P2	1	2	3	4	5	6	7	8	P3	P4		
2-6600333-9	D	VM	VM	ES	EV	EV	EV	EV	EV	EV	EV	EV	EV	VM	
	C			EV	EV	EV	EV	EV	EV	EV	EV				
	B			EV	EV	EV	EV	EV	EV	EV	EV				
	A			ES	EV	EV	EV	EV	EV	EV	ES				
2P+32S+2P															HD

NO CONTACT LOADED

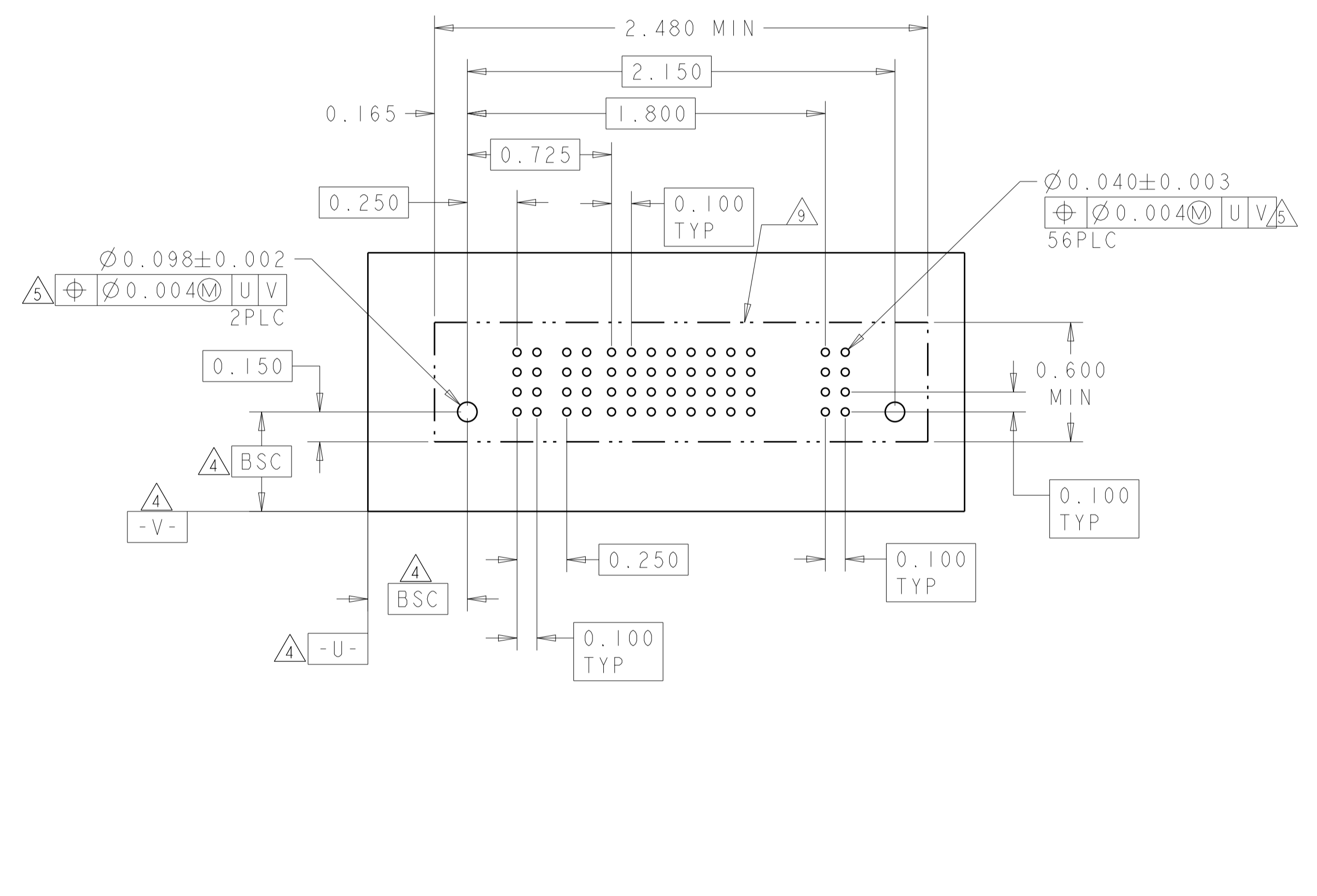
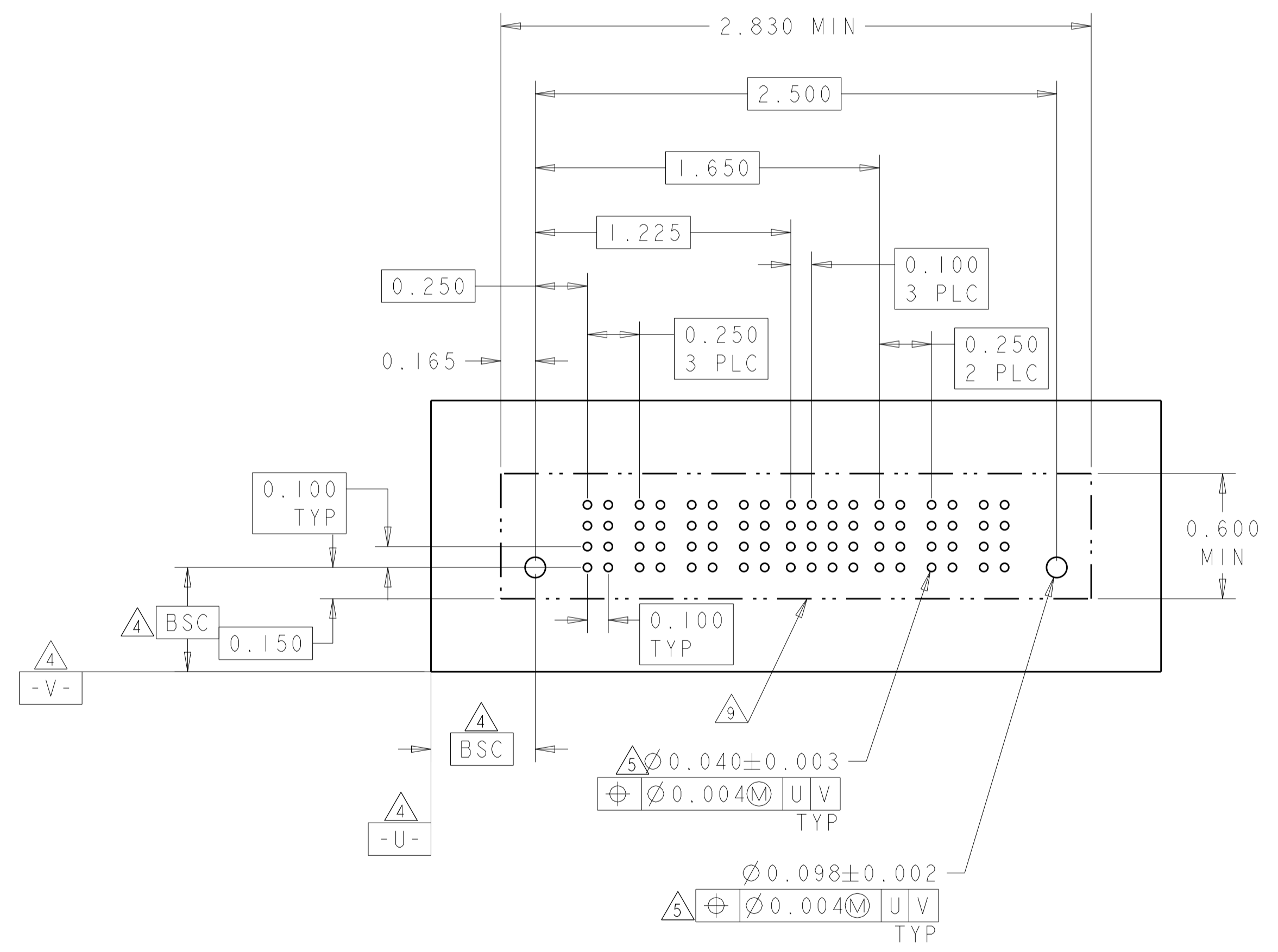

THIS DRAWING IS A CONTROLLED DOCUMENT.

DIMENSIONS:	TOLERANCES UNLESS OTHERWISE SPECIFIED:	DMN	J. McCLINTON	23MAR2005
INCH	0 PLC ±.01	CHK	D. TROUT	23MAR2005
	1 PLC ±.01	APVD	P. MLYNE	23MAR2005
	2 PLC ±.01	PRODUCT SPEC		
	3 PLC ±.005	108-1973		
	4 PLC ±.0020	APPLICATION SPEC		
	ANGLES ±.2°	114-13038		
MATERIAL	FINISH	WEIGHT		

Customer Drawing

SCALE 3:1 SHEET 10 OF 22 REV P7

STE TE Connectivity

VERTICAL HEADER ASSEMBLY, W/GUIDES, PRESS FIT, TYPE PSP MULTI-BEAM XL

SIZE CAGE CODE DRAWING NO RESTRICTED TO

A100779C=6600333

LOC	DIST	REV	DATE	BY	APPD
ES	00				
REVISIONS			DESCRIPTION	DATE	BY
			SEE SHEET 1		

PART NUMBER	ROWS	POWER						SIGNAL						POWER							
		P1	P2	P3	P4	P5	P6	1	2	3	4	5	6	P7	P8	P9	P10	P11	P12	P13	P14
3-6600333-1	D	VM	VM	VM	VM	VM	EV	EV	EV	EV	EV	EV	VM	VM	VM	VM	VM	VM			
	C						EV	EV	EV	EV	EV	EV									
	B						EV	EV	EV	EV	EV	EV									
	A						ES	ES	EV	EV	EV	EV									
6ACP + 24S + 8P																					

PART NUMBER	ROWS	POWER				SIGNAL						POWER			
		P1	P2	P3	P4	1	2	3	4	5	6	P5	P6	P7	P8
3-6600333-2	D	VM	VM	VM	VM	EV	EV	EV	EV	EV	EV	VM	VM	VM	VM
	C					EV	EV	EV	EV	EV	EV				
	B					EV	EV	EV	EV	EV	EV				
	A					EV	EV	EV	EV	EV	EV				
4P+24S+4P															

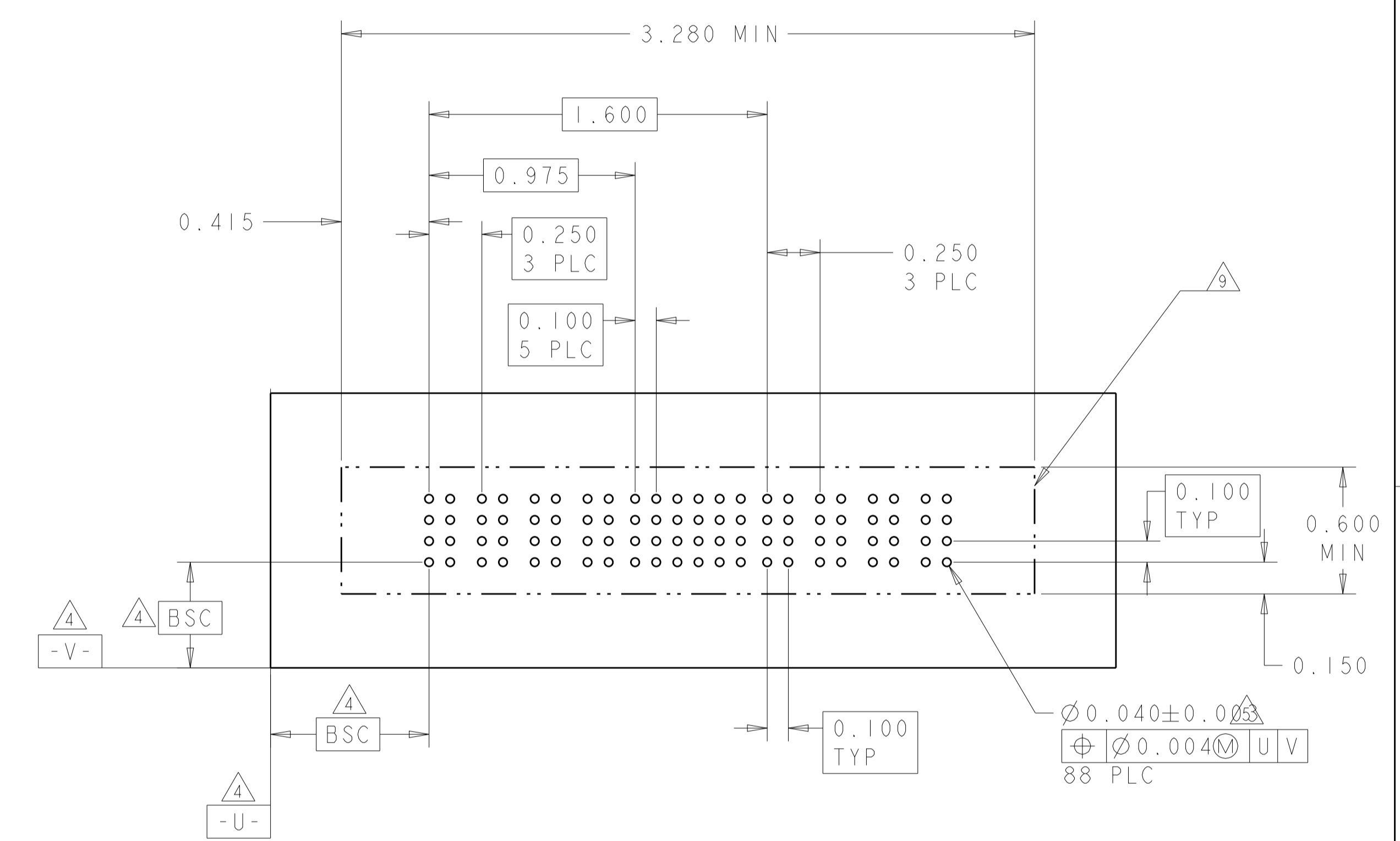
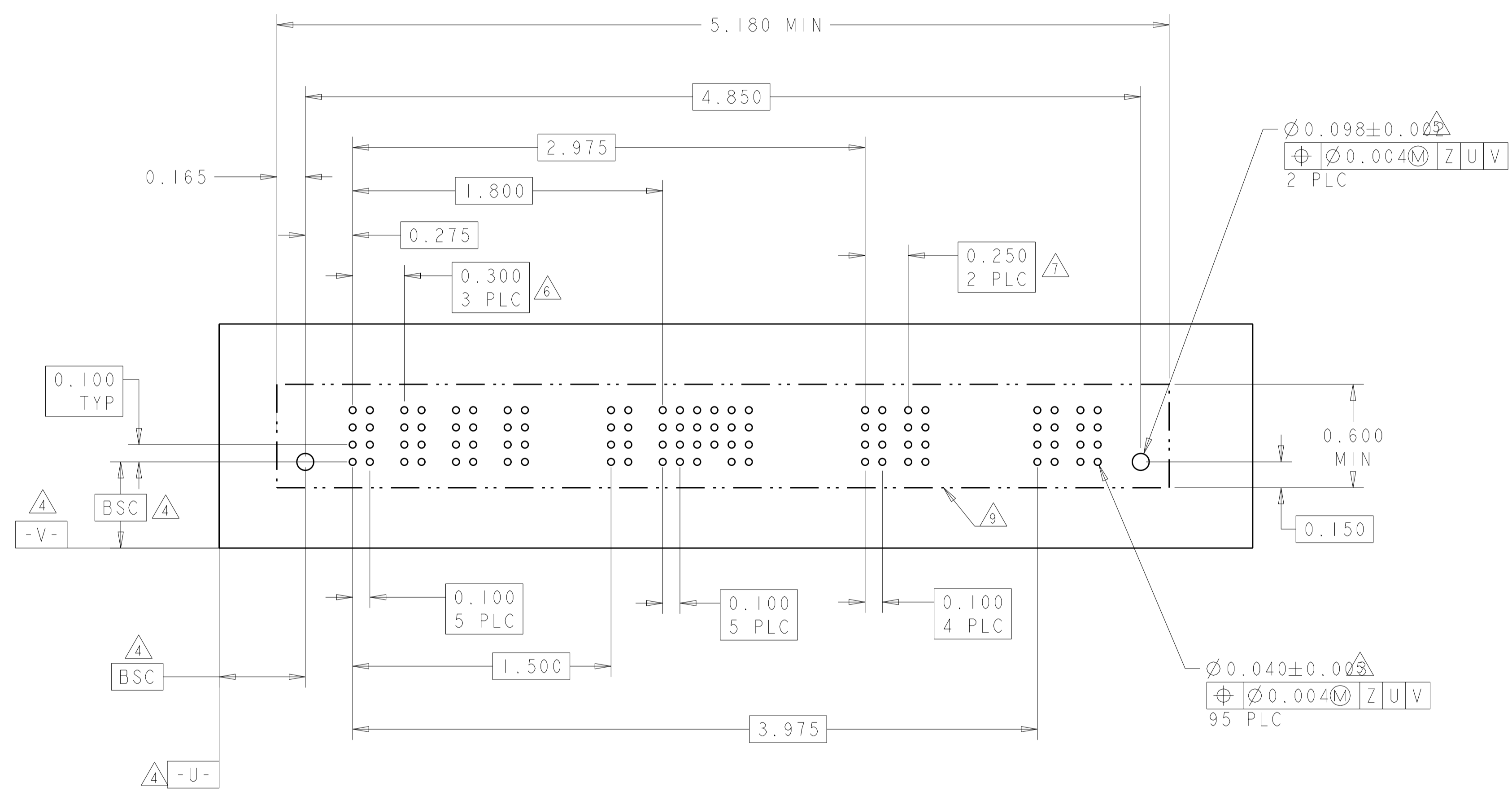

THIS DRAWING IS A CONTROLLED DOCUMENT.

DIMENSIONS:	TOLERANCES UNLESS OTHERWISE SPECIFIED:	OWN	23MAR2005
INCH	0 PLC ±	J. McCLINTON	23MAR2005
	1 PLC ±.01	D. TROUT	23MAR2005
	2 PLC ±.01	P. WHYNE	23MAR2005
	3 PLC ±.005		
	4 PLC ±.0020		
	ANGLES ±.020		
	FINISH		

MATERIAL: -

Customer Drawing

NAME: VERTICAL HEADER ASSEMBLY, W/GUIDES, PRESS FIT, TYPE PSP MULTI-BEAM XL

SIZE: A1

SCALE: 3:1

SHEET 11 OF 22

REV P7

LOC	DIST	REV	DATE	BY	APPV
ES	00				
REVISIONS			DESCRIPTION	DATE	BY
			SEE SHEET 1		

PART NUMBER	ROWS	POWER				SIGNAL		POWER			
		P1	P2	P3	P4	1	2	P5	P6	P7	P8
3-6600333-4	D C B A	VM	VM	VM	VM	EV	EV	VM	VM	VM	VM
4P + 8S + 4P											

PART NUMBER	ROWS	POWER				SIGNAL				POWER			
		P1	P2	P3	P4	1	2	3	4	P5	P6	P7	P8
3-6600333-3	D C B A	VM	VM	VM	VM	EV	EV	EV	EV	VM	VM	VM	VM
4P + 16S + 4P													

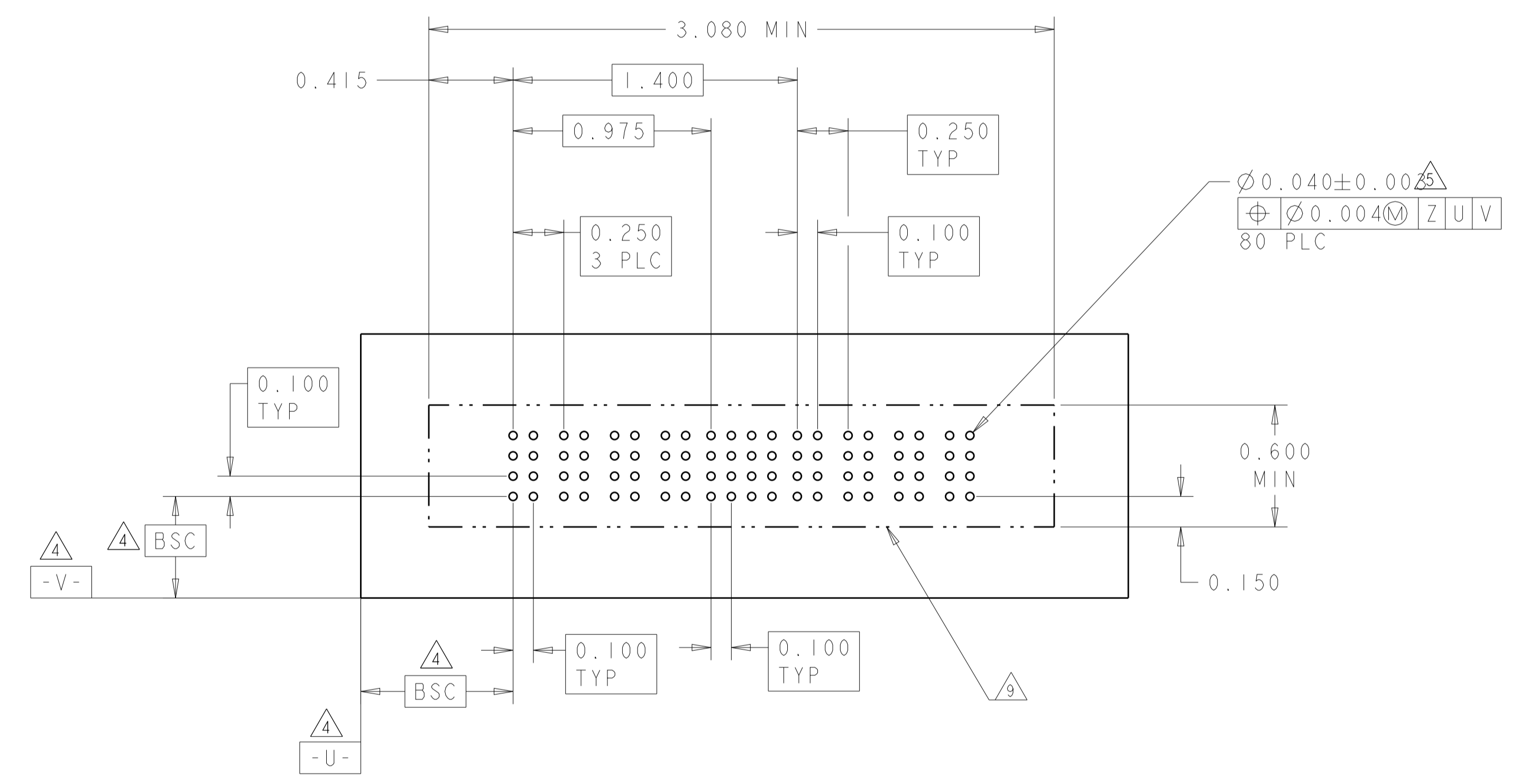
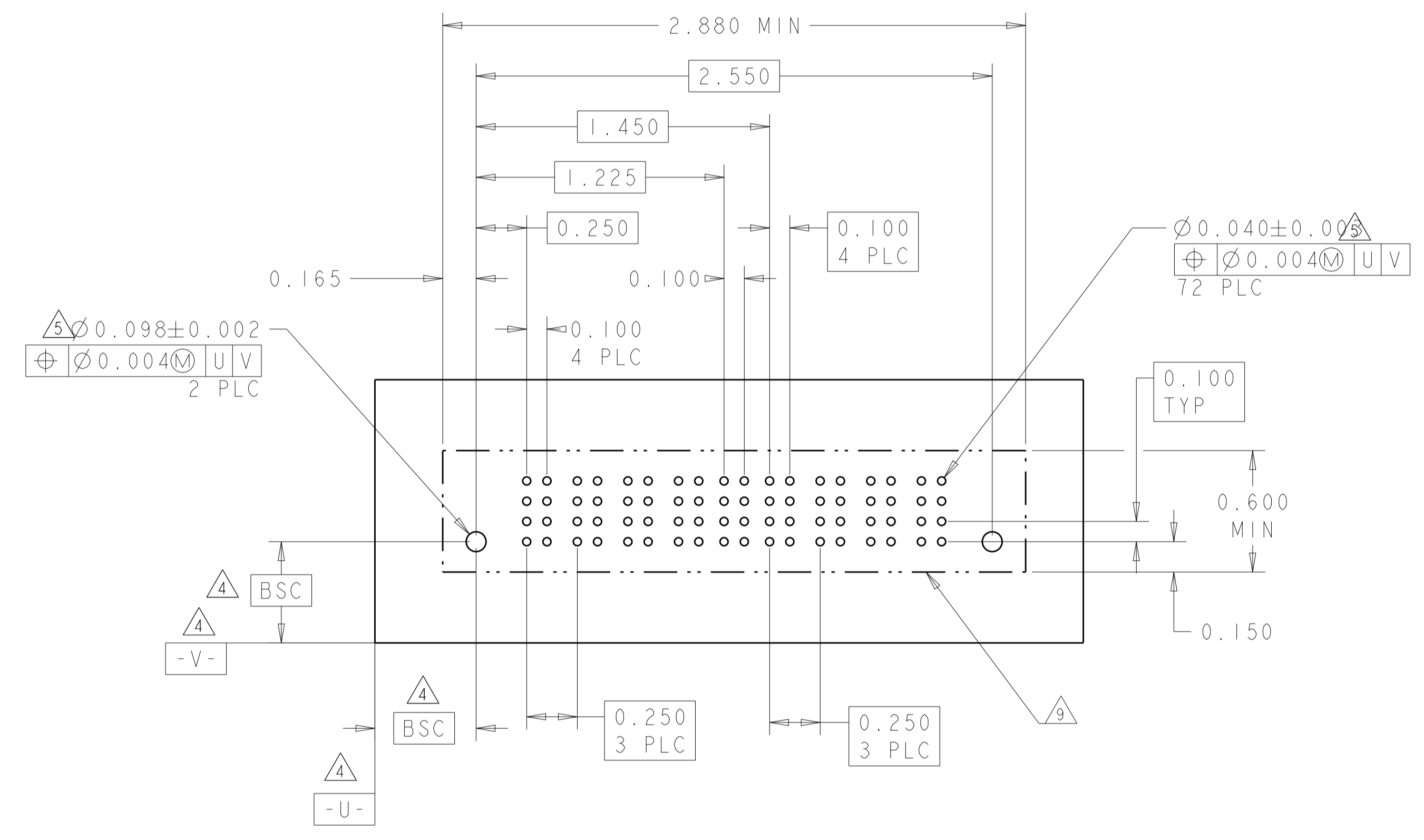

THIS DRAWING IS A CONTROLLED DOCUMENT.		OWN J. McCLINTON 23MAR2005	 TE Connectivity										
DIMENSIONS: INCH		CHK D. TROUT 23MAR2005											
TOLERANCES UNLESS OTHERWISE SPECIFIED:		APV B. WHYNE 23MAR2005	NAME VERTICAL HEADER ASSEMBLY, W/GUIDES, PRESS FIT, TYPE PSP MULTI-BEAM XL										
<table border="1"> <tr> <td>0 PLC</td> <td>±</td> </tr> <tr> <td>2 PLC</td> <td>±.01</td> </tr> <tr> <td>3 PLC</td> <td>±.005</td> </tr> <tr> <td>4 PLC</td> <td>±.0020</td> </tr> <tr> <td>ANGLES</td> <td>±.020</td> </tr> </table>		0 PLC	±	2 PLC	±.01	3 PLC	±.005	4 PLC	±.0020	ANGLES	±.020	PRODUCT SPEC 108-1973	SIZE A100779
0 PLC	±												
2 PLC	±.01												
3 PLC	±.005												
4 PLC	±.0020												
ANGLES	±.020												
MATERIAL		APPLICATION SPEC 114-13038	RESTRICTED TO										
FINISH		WEIGHT	SCALE 3:1										
		Customer Drawing	SHEET 12 OF 22										

LOC		DIST		REVISIONS				
P	LTN	DESCRIPTION	DATE	DMN	APVD			
ES	00	SEE SHEET 1						

PART NUMBER	ROWS	POWER			SIGNAL						POWER			
		P1	P2	P3	1	2	3	4	5	6	P4	P5	P6	
3-6600333-5	D	VM	VM	VM	EV	EV	EV	EV	EV	EV	VM	VM	VM	
	C				EV	EV	EV	EV	EV	EV				
	B				EV	EV	EV	EV	EV	EV				
	A				EV	EV	EV	EV	EV	EV				
3P+24S+3P														

PART NUMBER	ROWS	POWER		SIGNAL						POWER		
		P1	P2	1	2	3	4	5	6	P3	P4	
3-6600333-7	D	VM	VM	ES	EV	EV	EV	EV	EV	VM	VM	
	C			ES	EV	EV	EV	EV	EV			
	B			EV	EV	EV	EV	EV	EV			
	A			ES	EV	EV	EV	EV	EV			
2P+24S+2P												

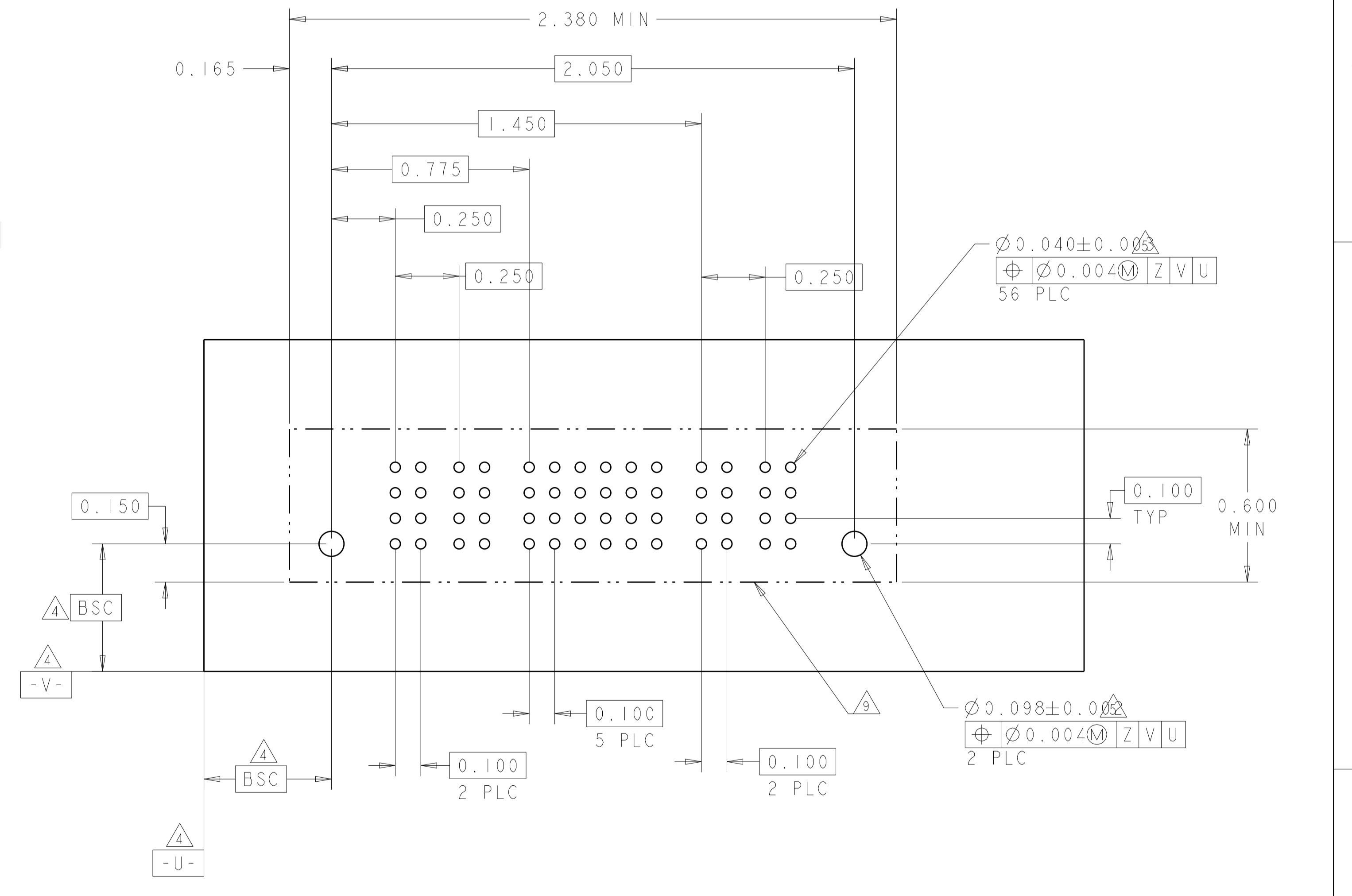
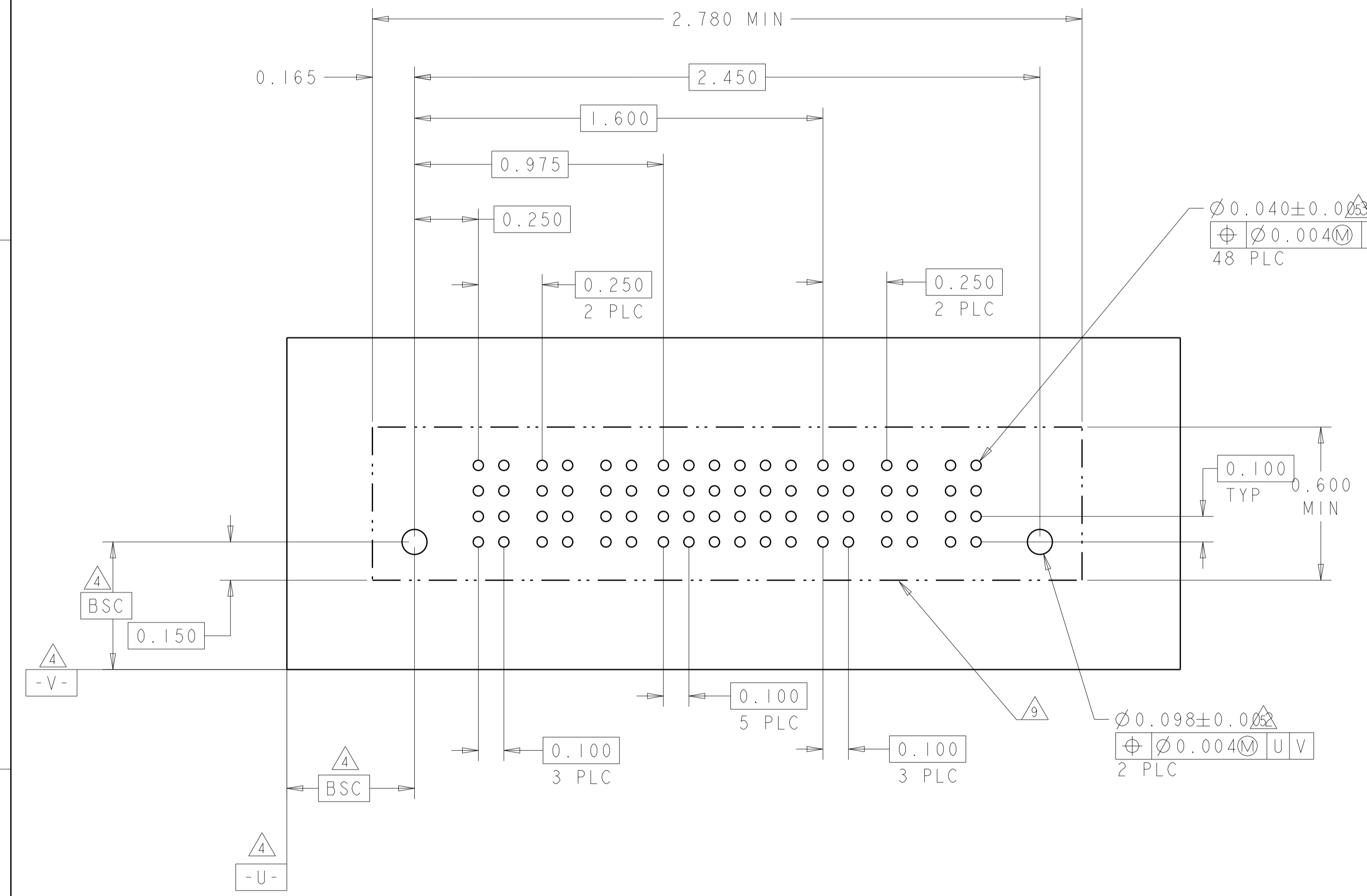

THIS DRAWING IS A CONTROLLED DOCUMENT.

DIMENSIONS:	TOLERANCES UNLESS OTHERWISE SPECIFIED:	DMN	J. McCLINTON	23MAR2005
INCH	0 PLC ± 1 PLC ±.01 2 PLC ±.01 3 PLC ±.005 4 PLC ±.002 ANGLES ±.020	CHK	D. TROUT	23MAR2005
MATERIAL	FINISH	APVD	B. WHYNE	23MAR2005

NAME: VERTICAL HEADER ASSEMBLY, W/GUIDES, PRESS FIT, TYPE PSP MULTI-BEAM XL
 SIZE: A1
 CAGE CODE: 114-13038
 DRAWING NO: 108-1973
 APPLICATION SPEC: 114-13038
 WEIGHT: -
 Customer Drawing
 SCALE: 3:1
 SHEET: 13 OF 22
 REV: P7

LOC	DIST	REVISIONS					
		P	LTN	DESCRIPTION	DATE	DMN	APVD
ES	00	-	-	SEE SHEET 1	-	-	-

PART NUMBER	ROWS	POWER				SIGNAL														POWER			
		P1	P2	P3	P4	1	2	3	4	5	6	7	8	9	10	11	12	13	14	P5	P6	P7	P8
3-6600333-6	D					EV	EV	EV	EV	EV	EV	EV	EV	EV	EV	EV	EV	EV	EV	EV	EV	EV	EV
	C					EV	EV	EV	EV	EV	EV	EV	EV	EV	EV	EV	EV	EV	EV	EV	EV	EV	EV
	B					EV	EV	EV	EV	EV	EV	EV	EV	EV	EV	EV	EV	EV	EV	EV	EV	EV	EV
	A					EV	EV	EV	EV	EV	EV	EV	EV	EV	EV	EV	EV	EV	EV	EV	EV	EV	EV
4P+56S+4P																							

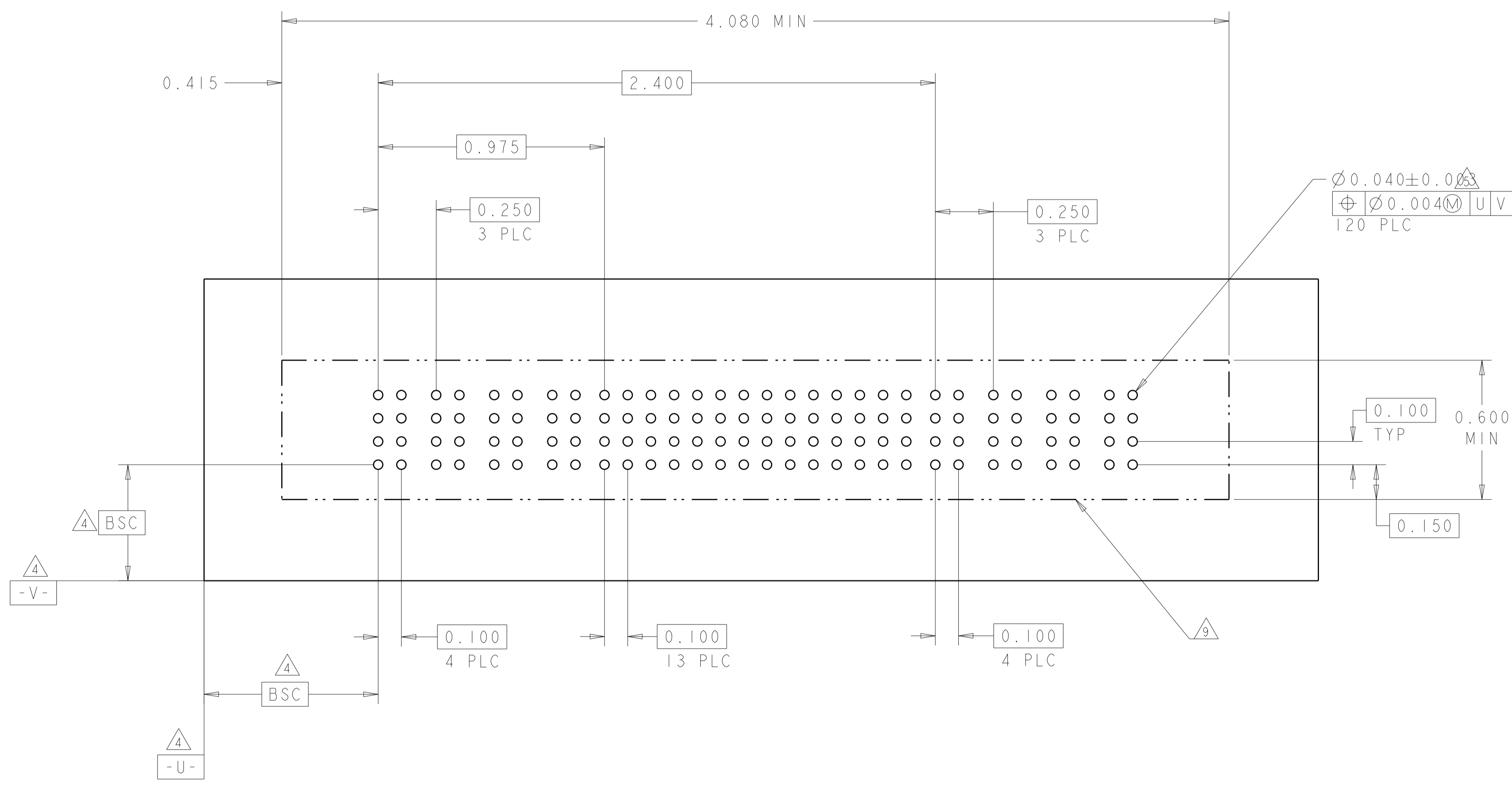

THIS DRAWING IS A CONTROLLED DOCUMENT.

DIMENSIONS:	TOLERANCES UNLESS OTHERWISE SPECIFIED:	DMN	J. McCLINTON	23MAR2005
INCH	0 PLC ±	CHK	D. TROUT	23MAR2005
	1 PLC ±.01	APVD	P. WHYNE	23MAR2005
	3 PLC ±.05	NAME	VERTICAL HEADER ASSEMBLY, W/GUIDES, PRESS FIT, TYPE PSP MULTI-BEAM XL	
	4 PLC ±.0020	PRODUCT SPEC	108-1973	
	ANGLES ±.2°	APPLICATION SPEC	114-13038	
MATERIAL	FINISH	SIZE	CAGE CODE	DRAWING NO
		A100779	C=6600333	
		WEIGHT		RESTRICTED TO
		Customer Drawing	SCALE 3:1	SHEET 14 OF 22

REV 7

LOC	DIST	REV	DATE	BY	APPD
ES	00				

REVISIONS					
REV	DATE	DESCRIPTION	BY	APPD	DATE
-	-	SEE SHEET 1	-	-	-

PART NUMBER	ROWS	POWER						SIGNAL		POWER					
		P1	P2	P3	P4	P5	P6	I	2	P7	P8	P9	P10	P11	P12
3-6600333-8	D	VM	VM	VM	VM	VM	VM	EV	EV	VM	VM	VM	VM	VM	VM
	C							EV	EV						
	B							EV	EV						
	A							EV	EV						
6P+8S+6P		HD													HD

PART NUMBER	ROWS	POWER			SIGNAL						POWER		
		P1	P2	P3	1	2	3	4	5	6	P4	P5	P6
3-6600333-9	D	VM	VM	VM	EV	EV	EV	EV	EV	EV	VM	VM	VM
	C				EV	EV	EV	EV	EV				
	B				EV	EV	EV	EV	EV				
	A				EV	EV	EV	EV	EV				
3ACP+24S+3ACP		HD											HD

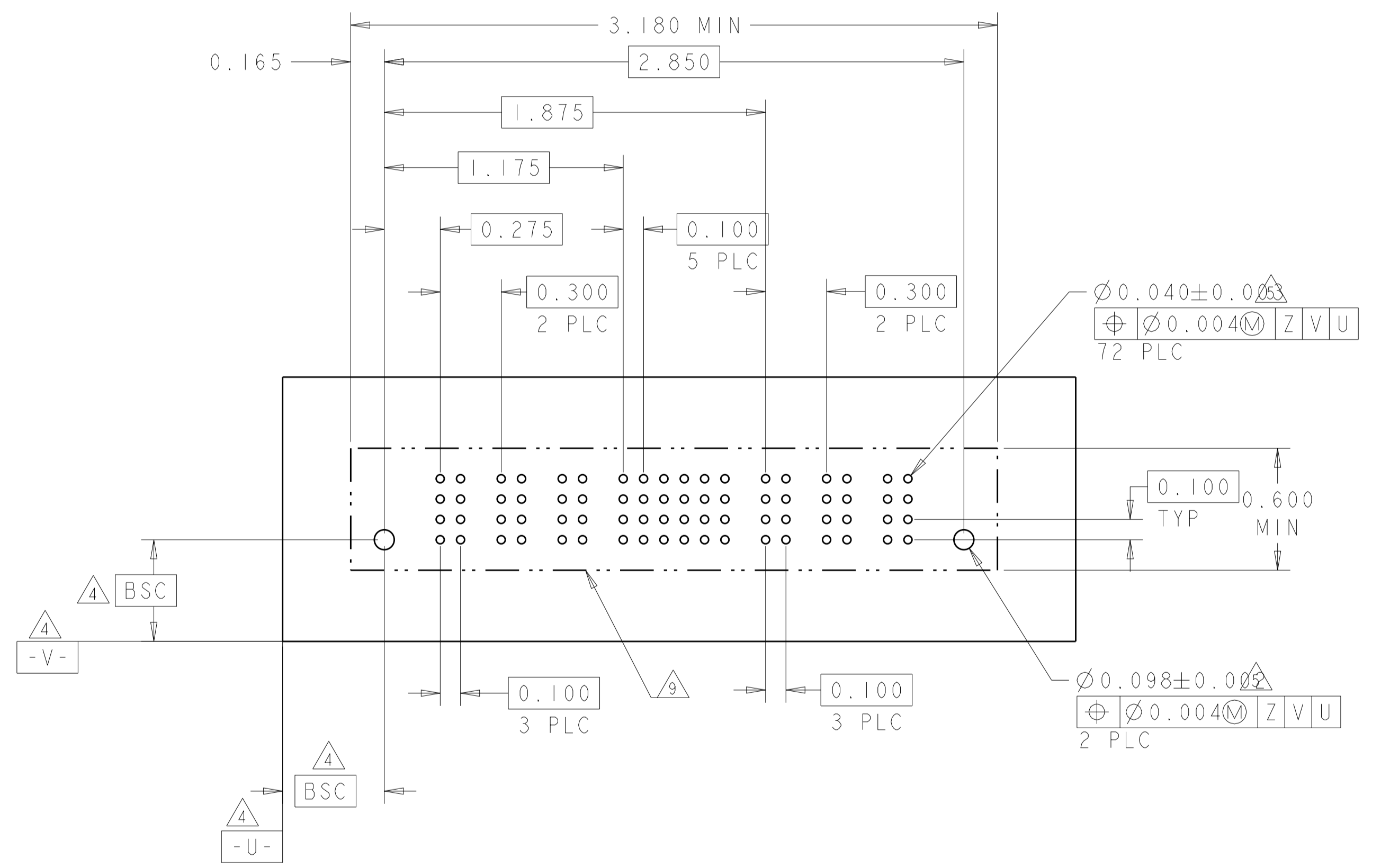
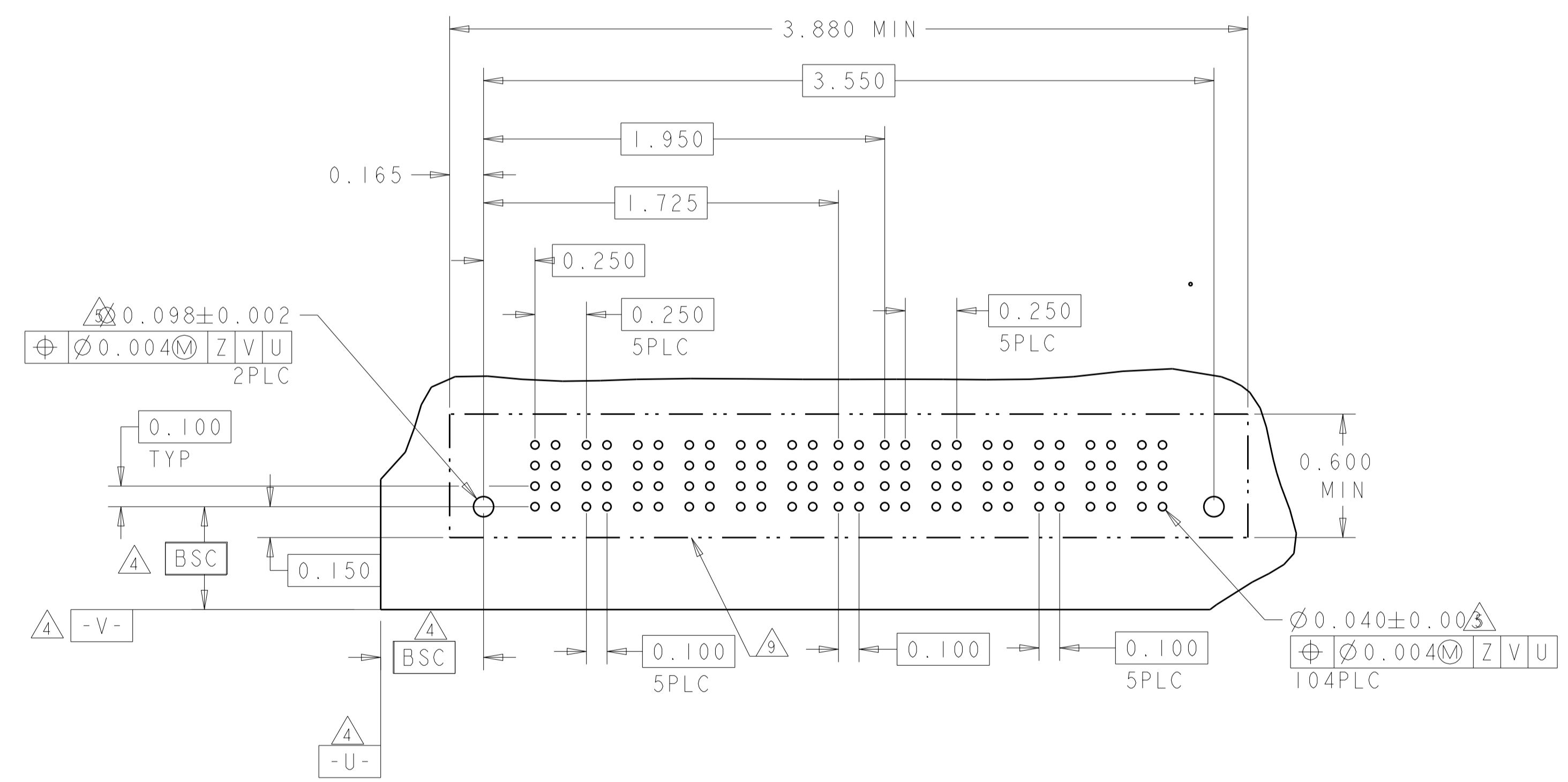

THIS DRAWING IS A CONTROLLED DOCUMENT.

DIMENSIONS:	TOLERANCES UNLESS OTHERWISE SPECIFIED:	OWN	J. McCLINTON	23MAR2005
INCH	0 PLC ±.01	CHK	D. TROUT	23MAR2005
	1 PLC ±.01	APPD	B. WHYNE	23MAR2005
	2 PLC ±.01	PRODUCT SPEC		
	3 PLC ±.005	APPLICATION SPEC		
	4 PLC ±.0020	SIZE	114-13038	
	ANGLES ±.020	WEIGHT		
MATERIAL	FINISH	Customer Drawing		

NAME: VERTICAL HEADER ASSEMBLY, W/GUIDES, PRESS FIT, TYPE PSP MULTI-BEAM XL

SIZE: A1 00779 C=6600333

SCALE: 3:1 SHEET 15 OF 22 REV P7

LOC	DIST	REV	DATE	BY	APPD
ES	00				
REVISIONS			DESCRIPTION	DATE	BY
			SEE SHEET 1		

PART NUMBER	ROWS	POWER		SIGNAL			POWER	
		P1	P2	1	2	3	P3	P4
4-6600330-1	D	VM	VM	EV	EV	EV	VM	VM
	C			EV	EV	EV		
	B			EV	EV	EV		
	A			EV	EV	EV		
2P + 12S + 2P		HD		HD				

PART NUMBER	ROWS	POWER		SIGNAL			POWER	
		P1	P2	1	2	3	P3	P4
4-6600333-9	D	VM	VM	ES	EV	EV	VM	VM
	C			EV	EV	EV		
	B			EV	EV	EV		
	A			EV	EV	EV		
IP+12S+IP		HD		HD				

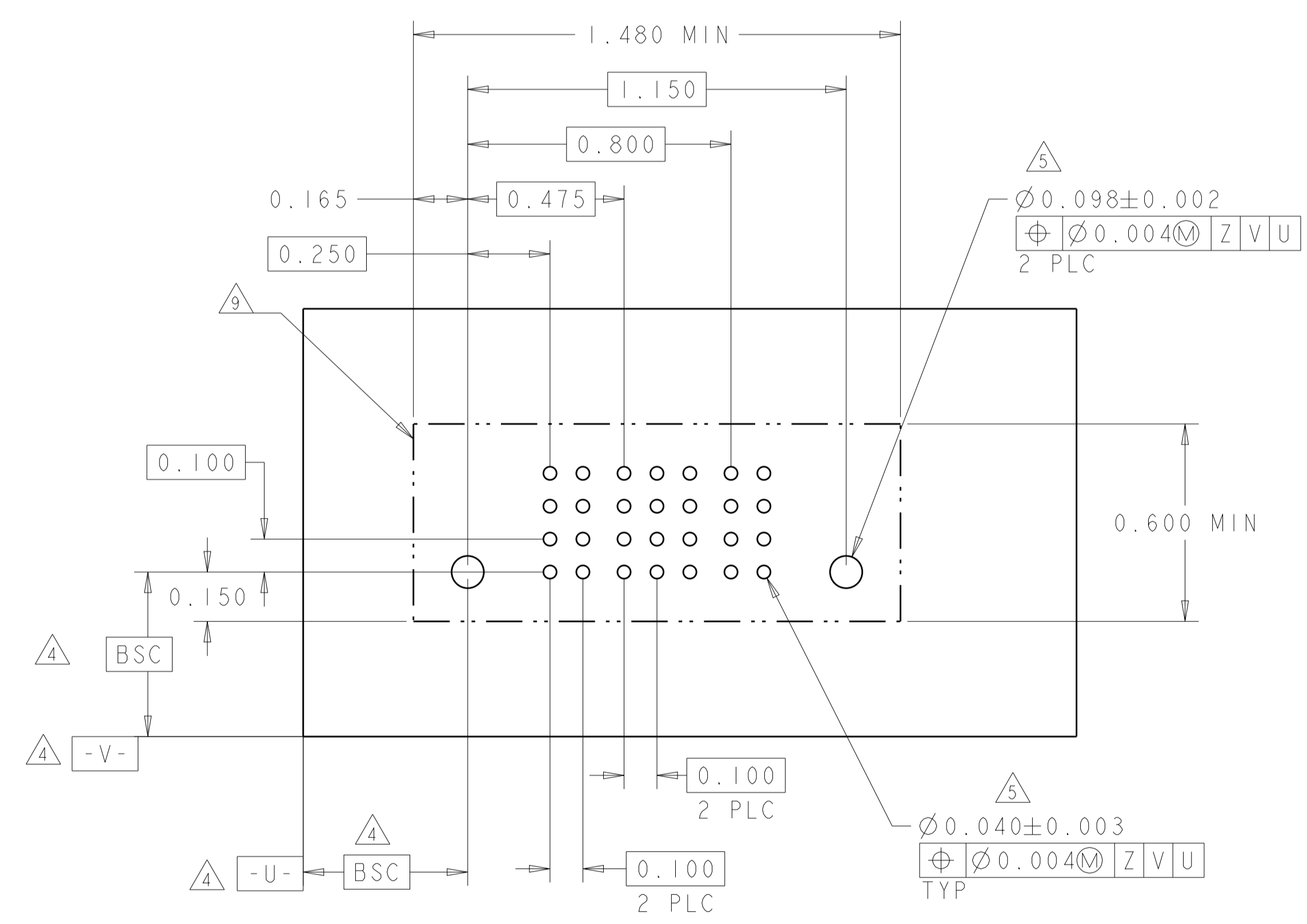
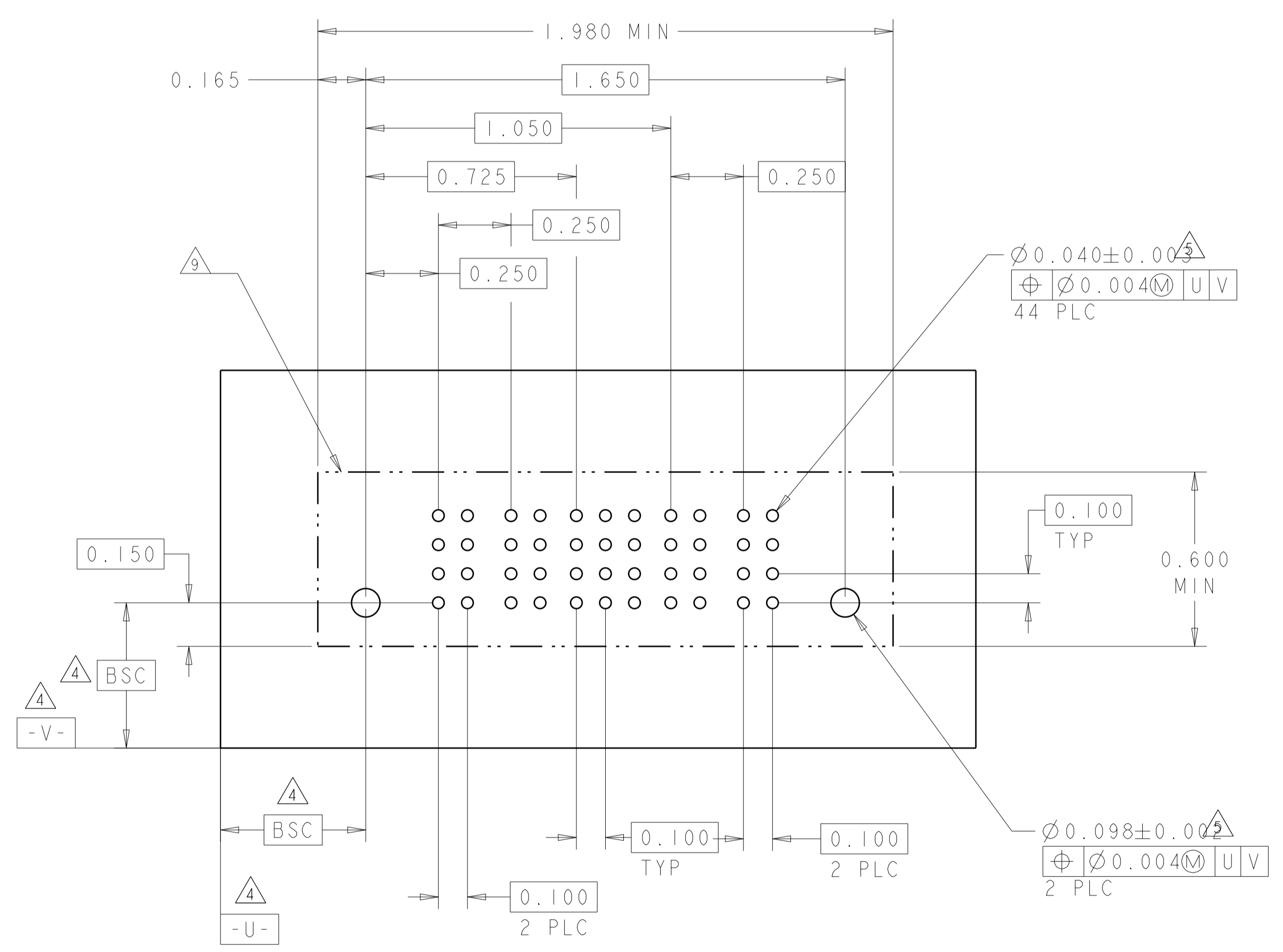

THIS DRAWING IS A CONTROLLED DOCUMENT.

DIMENSIONS: INCH
 TOLERANCES UNLESS OTHERWISE SPECIFIED:
 0 PLC ±.
 1 PLC ±.01
 2 PLC ±.005
 3 PLC ±.0025
 4 PLC ±.0020
 ANGLES ±.020
 FINISH:

DWG: J. McCLINTON 23MAR2005
 CHK: D. TROUT 23MAR2005
 APVD: B. MHYNE 23MAR2005
 PRODUCT SPEC: 108-1973
 APPLICATION SPEC: 114-13038
 WEIGHT: -
 Customer Drawing

STE TE Connectivity
 NAME: VERTICAL HEADER ASSEMBLY, W/GUIDES, PRESS FIT, TYPE PSP MULTI-BEAM XL
 SIZE: A100779
 CAGE CODE: C=6600333
 SCALE: 3:1 SHEET 16 OF 22 REV P7

LOC	DIST	REVISIONS			
P	LTN	DESCRIPTION	DATE	DMN	APVD
-	-	SEE SHEET 1	-	-	-

(N)

PART NUMBER	ROWS	POWER								SIGNAL				POWER								
		P1	P2	P3	P4	P5	P6	P7	P8	1	2	3	4	P9	P10	P11	P12	P13	P14	P15	P16	
4-6600333-2	D		VM	VM	VM	VM	VM	VM	VM	EV	EV	EV	EV	VM	VM	VM	VM	VM	VM	VM	VM	
	EV									EV	EV	EV										
	EV									EV	EV	EV										
	EV									EV	EV	EV										
8P+16S+8P	HD																					HD

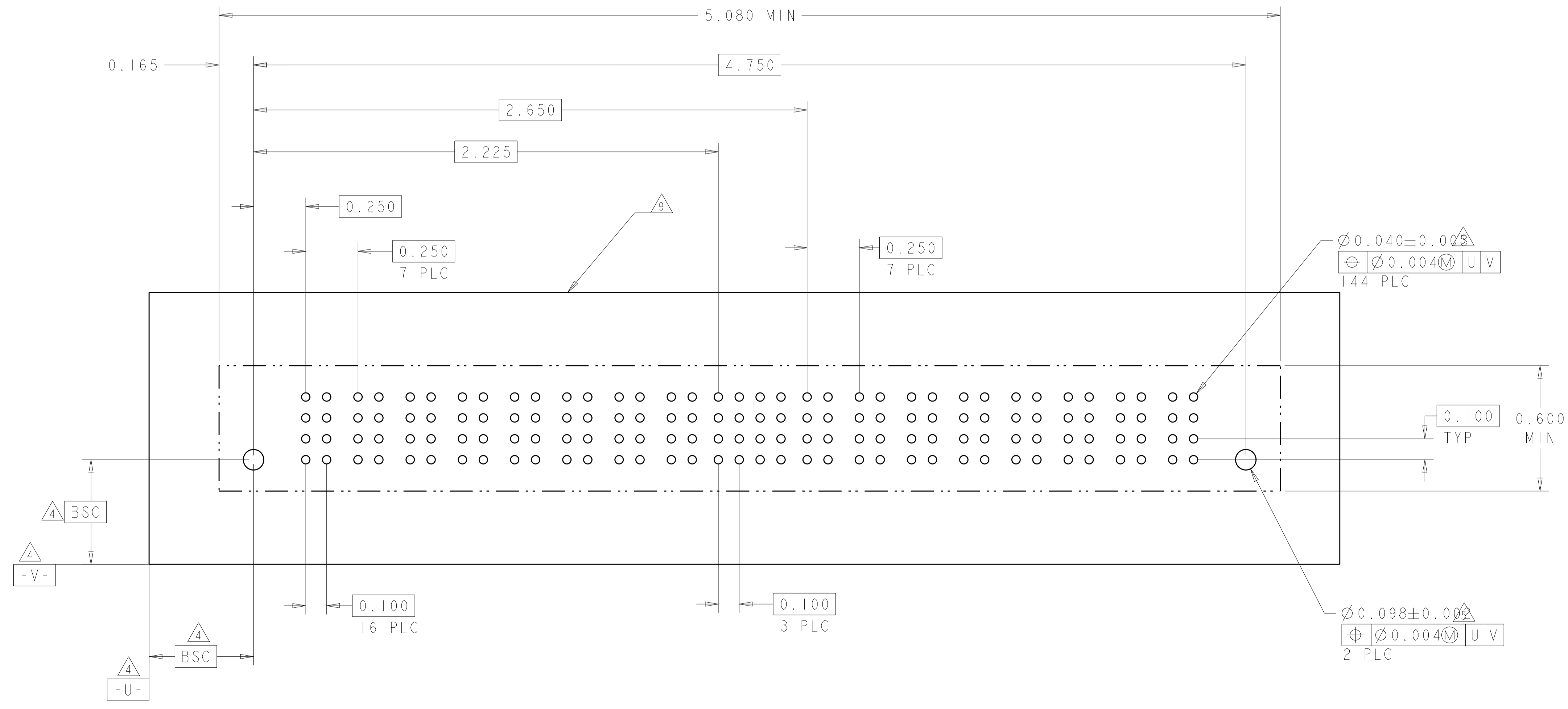

THIS DRAWING IS A CONTROLLED DOCUMENT.

DIMENSIONS: INCH	TOLERANCES UNLESS OTHERWISE SPECIFIED: 0 PLC ±. 1 PLC ±.01 2 PLC ±.01 3 PLC ±.005 4 PLC ±.0020 ANGLES ±.7°	DMN J. McCLINTON 23MAR2005	CHK D. TROUT 23MAR2005	APVD B. WHYNE 23MAR2005	NAME VERTICAL HEADER ASSEMBLY, W/GUIDES, PRESS FIT, TYPE PSP MULTI-BEAM XL
MATERIAL	FINISH	PRODUCT SPEC 108-1973	APPLICATION SPEC 114-13038	WEIGHT	SIZE A100779
Customer Drawing		SCALE 3:1		SHEET 17 OF 22	

RESTRICTED TO
REV P7

LOC	DIST	REVISIONS			
P	LTN	DESCRIPTION	DATE	DMN	APVD
ES	00	SEE SHEET 1	-	-	-

PART NUMBER	ROWS	POWER		SIGNAL						POWER	
		P1	P2	1	2	3	4	5	6	P3	P4
4-6600333-4	D	VM	VM	EV	EV	EV	EV	EV	EV	VM	VM
	C			EV	EV	EV	EV	EV			
	B			EV	EV	EV	EV	EV			
	A			ES	ES	ES	ES	ES			
2P+24S+2P											

PART NUMBER	ROWS	POWER				SIGNAL			POWER			
		P1	P2	P3	P4	1	2	3	P5	P6	P7	P8
4-6600333-6	D	VM	VM	VM	VM	EV	EV	EV	VM	VM	VM	VM
	C					EV	EV	EV				
	B					EV	EV	EV				
	A					EV	EV	EV				
4P + 12S + 4P												

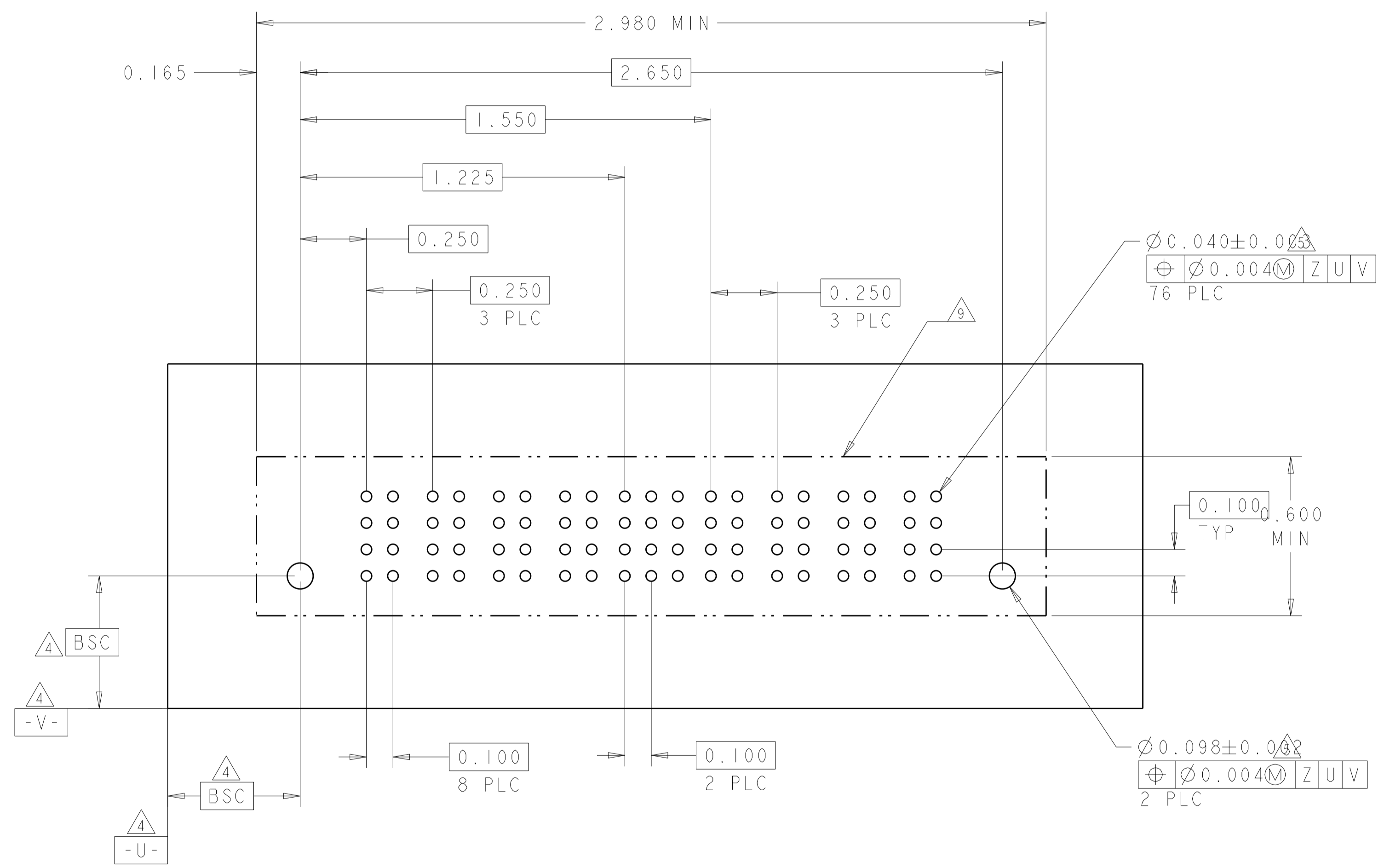
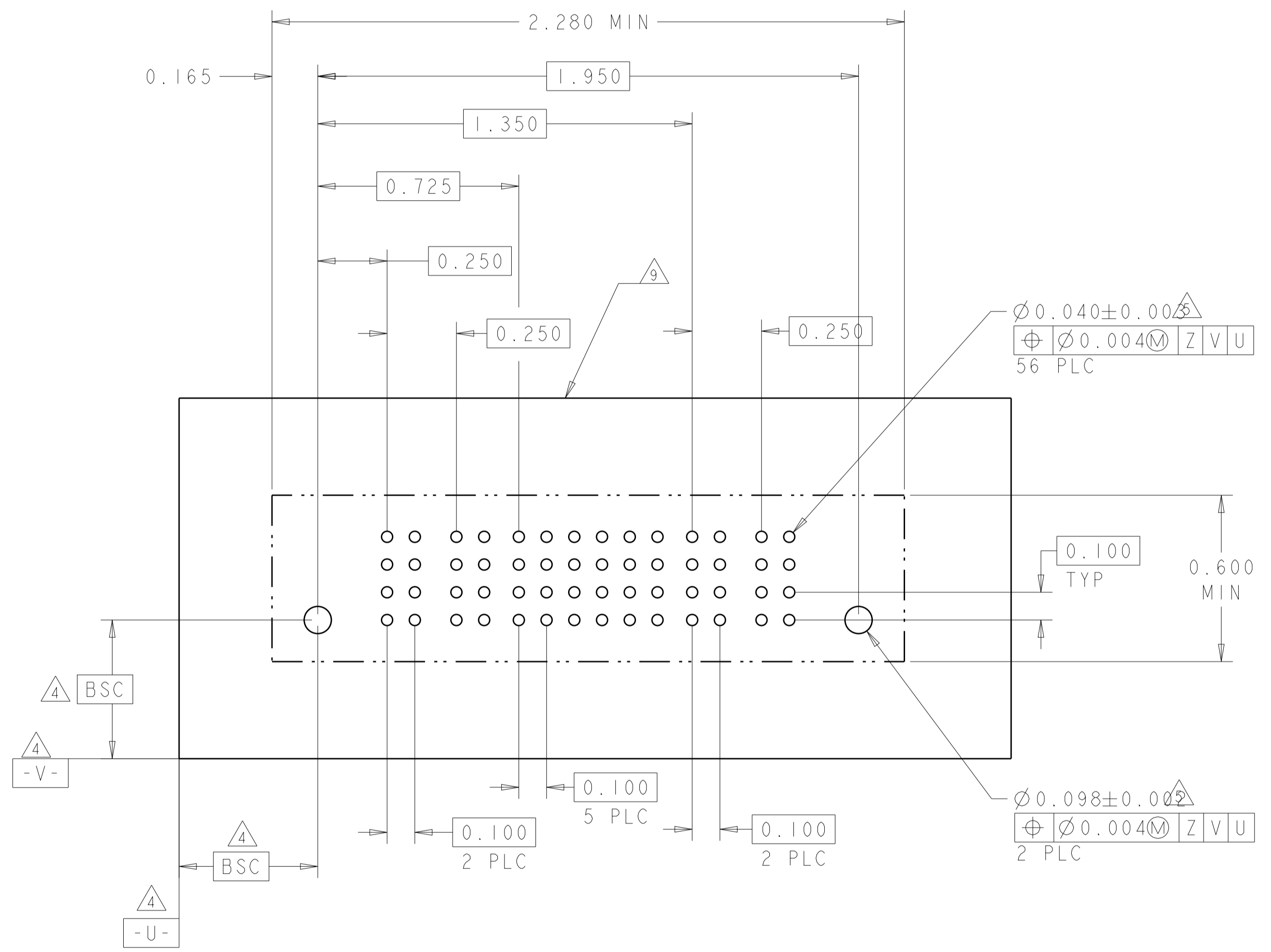

THIS DRAWING IS A CONTROLLED DOCUMENT.

DIMENSIONS:	TOLERANCES UNLESS OTHERWISE SPECIFIED:	DMN	J. McCLINTON	23MAR2005
INCH	0 PLC ±.01	CHK	D. TROUT	23MAR2005
	1 PLC ±.01	APVD	P. WHYNE	23MAR2005
	2 PLC ±.01	PRODUCT SPEC		
	3 PLC ±.005	APPLICATION SPEC		
	4 PLC ±.0020	SIZE	114-13038	
	ANGLES ±.7°	WEIGHT		
MATERIAL	FINISH	Customer Drawing		

NAME: VERTICAL HEADER ASSEMBLY, W/GUIDES, PRESS FIT, TYPE PSP MULTI-BEAM XL
 SIZE: A100779 C=6600333
 SCALE: 3:1 SHEET 18 OF 22 REV P7

LOC	DIST	REV	DATE	BY	APPV
ES	00				
REVISIONS					
DESCRIPTION			DATE	BY	APPV
SEE SHEET 1					

PART NUMBER	ROWS	POWER		SIGNAL						POWER	
		P1	P2	1	2	3	4	5	6	P3	P4
4-6600333-3	D	VM	VM	ES	EV	EV	EV	EV	EV	VM	VM
	C			EV	EV	EV	EV	EV			
	B			EV	EV	EV	EV	EV			
	A			EV	EV	EV	EV	EV			
2ACP+24S+2ACP	HD										

PART NUMBER	ROWS	POWER		SIGNAL						POWER	
		P1	P2	1	2	3	4	5	6	P3	P4
4-6600333-5	D	VM	VM	EV	EV	EV	EV	EV	EV	VM	VM
	C			EV	EV	EV	EV	EV			
	B			EV	EV	ES	EV	EV	EV		
	A			ES	EV	EV	EV	EV	EV		
2ACP+24S+2ACP	HD										

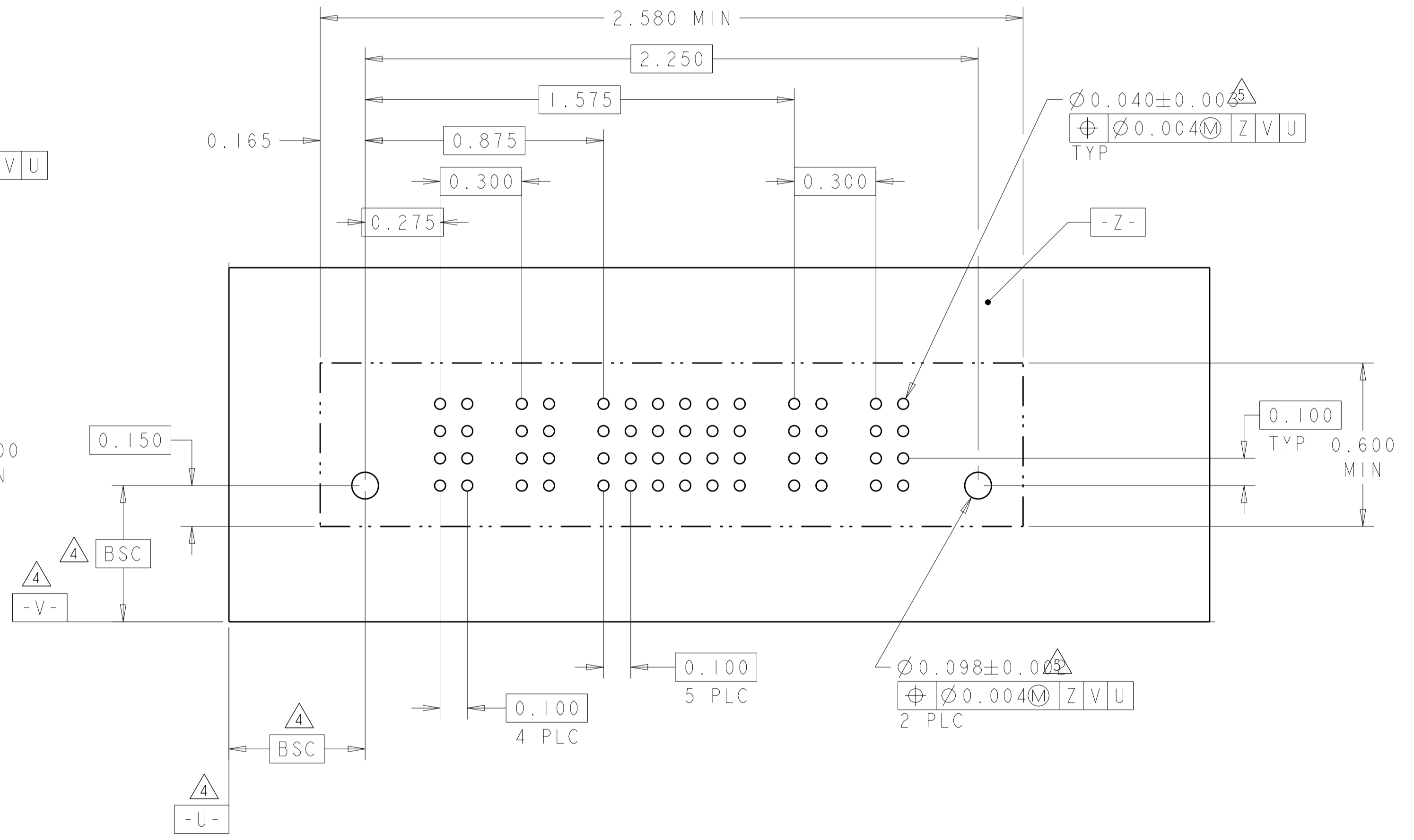
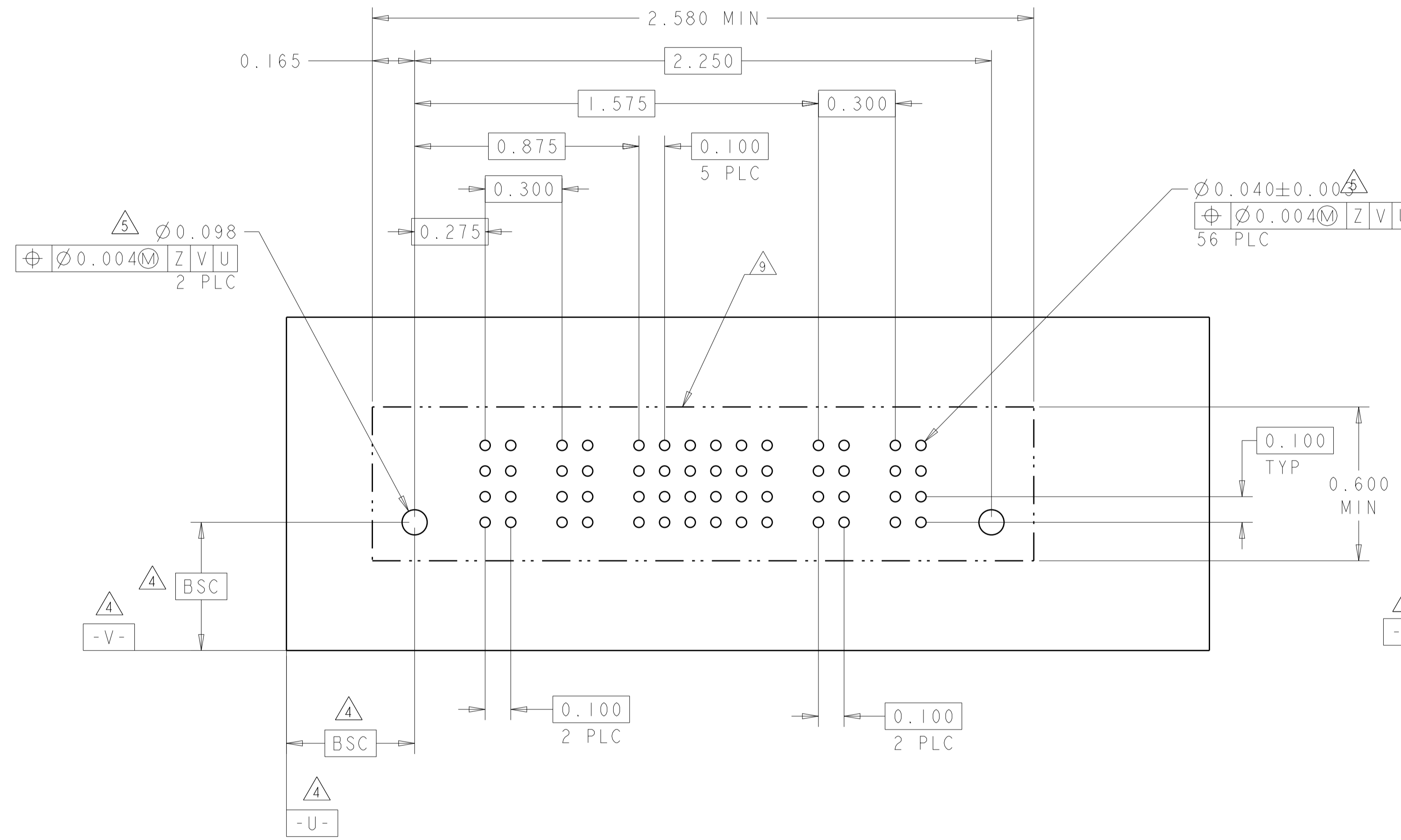

THIS DRAWING IS A CONTROLLED DOCUMENT.

DIMENSIONS:	TOLERANCES UNLESS OTHERWISE SPECIFIED:	OWN	23MAR2005
INCH	0 PLC ±	J. McCLINTON	23MAR2005
	1 PLC ±.01	D. TROUT	23MAR2005
	2 PLC ±.02	P. WHYNE	23MAR2005
	3 PLC ±.05		
	4 PLC ±.0020		
	ANGLES ±.2°		
MATERIAL	FINISH	PRODUCT SPEC	NAME
		108-1973	VERTICAL HEADER ASSEMBLY, W/GUIDES, PRESS FIT, TYPE PSP
		APPLICATION SPEC	MULTI-BEAM XL
		114-13038	SIZE CAGE CODE DRAWING NO
		WEIGHT	A100779C=6600333
		Customer Drawing	RESTRICTED TO
		SCALE 3:1	SHEET 19 OF 22
			REV P7

STE TE Connectivity

LOC	DIST	REVISIONS					
		P	LTN	DESCRIPTION	DATE	DMN	APVD
ES	00	-	-	SEE SHEET 1	-	-	-

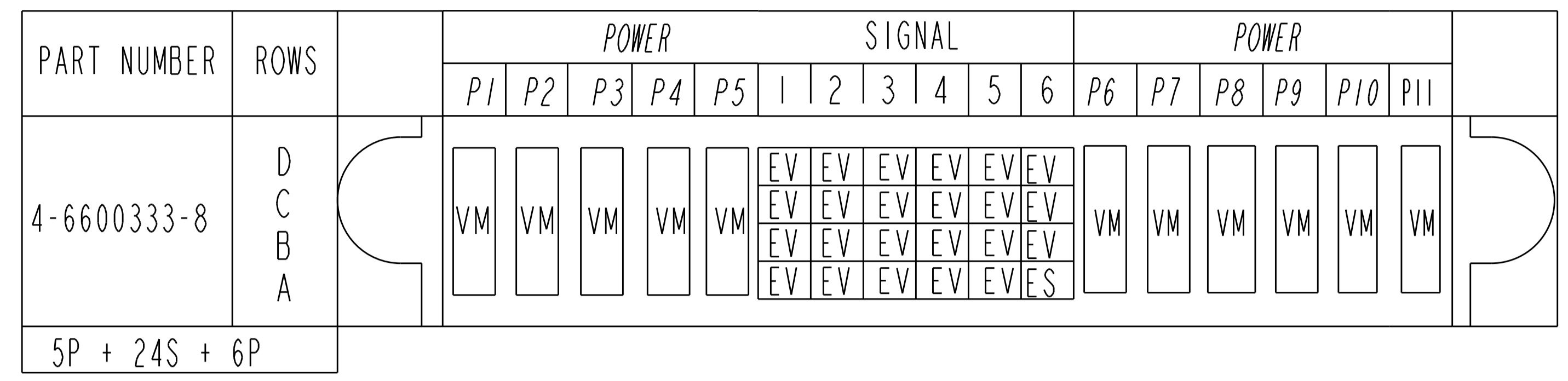

(N7)

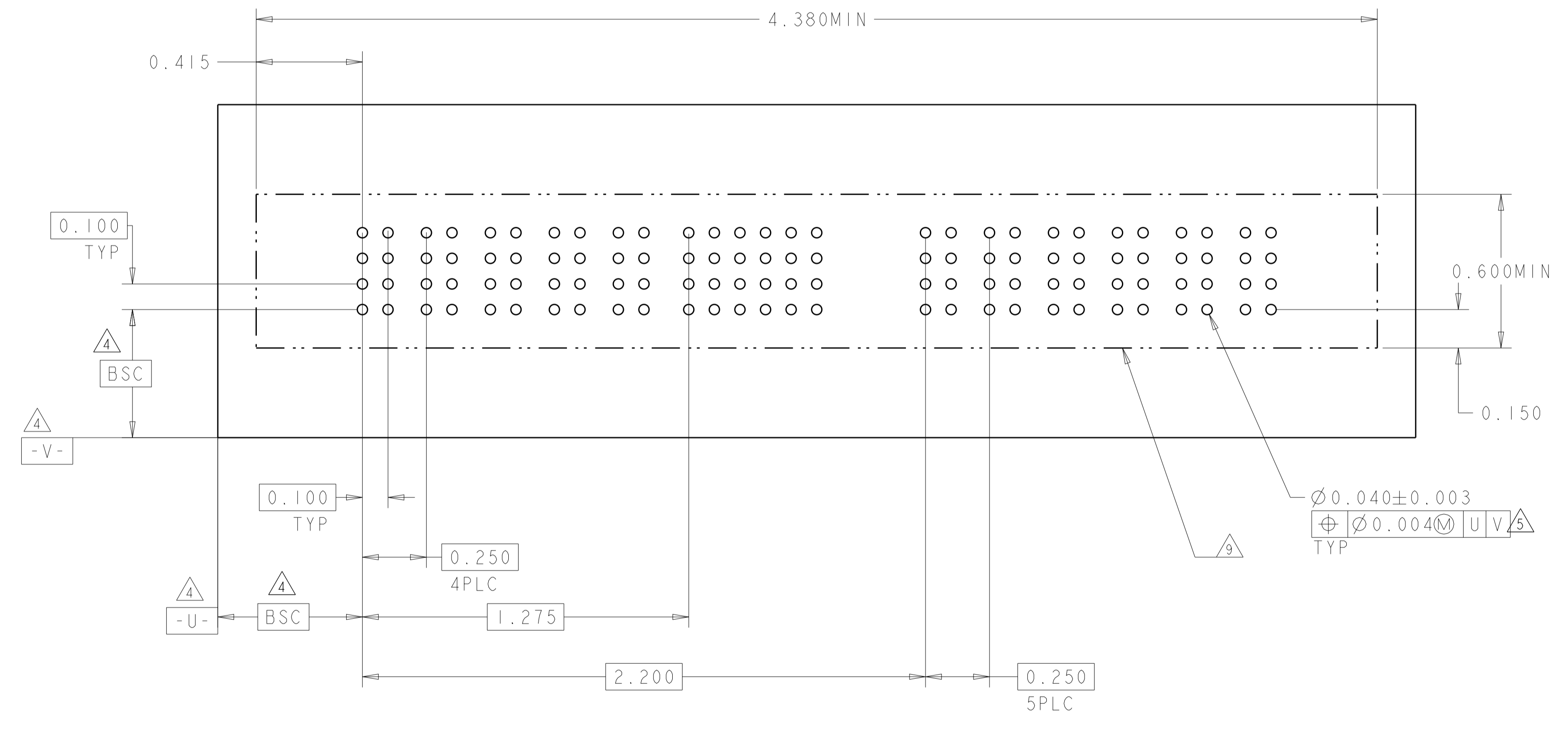

(N6)

RECOMMENDED PCB LAYOUT 4-6600333-8

THIS DRAWING IS A CONTROLLED DOCUMENT.		DMN J. McCLINTON 23MAR2005	TE Connectivity
DIMENSIONS: INCH		CHK D. TROUT 23MAR2005	
DIMENSIONS: INCH TOLERANCES UNLESS OTHERWISE SPECIFIED: 0 PLC ±. 1 PLC ±.01 2 PLC ±.01 3 PLC ±.005 4 PLC ±.0020 ANGLES ±7°		APVD B. WHYNE 23MAR2005	NAME VERTICAL HEADER ASSEMBLY, W/GUIDES, PRESS FIT, TYPE PSP MULTI-BEAM XL
MATERIAL		PRODUCT SPEC 108-1973	SIZE 114-13038
		APPLICATION SPEC 114-13038	RESTRICTED TO
		WEIGHT	A100779C=6600333
		Customer Drawing	SCALE 3:1 SHEET 20 OF 22 REV P7

LOC	DIST	REVISIONS					
		P	LTN	DESCRIPTION	DATE	DWN	APVD
ES	00	-	-	SEE SHEET 1	-	-	-

PART NUMBER	ROWS	POWER		SIGNAL												POWER			
		P1	P2	1	2	3	4	5	6	7	8	9	10	11	12	P3	P4		
5-6600333-2	D	VM	VM	EV	EV	EV	EV	EV	EV	EV	EV	EV	EV	EV	EV	EV	EV	EV	
	C			EV	EV	EV	EV	EV	EV	EV	EV	EV	EV	EV	EV	EV	EV	EV	
	B			EV	EV	EV	EV	EV	EV	EV	EV	EV	EV	EV	EV	EV	EV	EV	EV
	A			ES	ES	ES	ES	ES	ES	ES	EV	EV	EV	EV	EV	EV	EV	EV	EV
2P+48S+2P																			

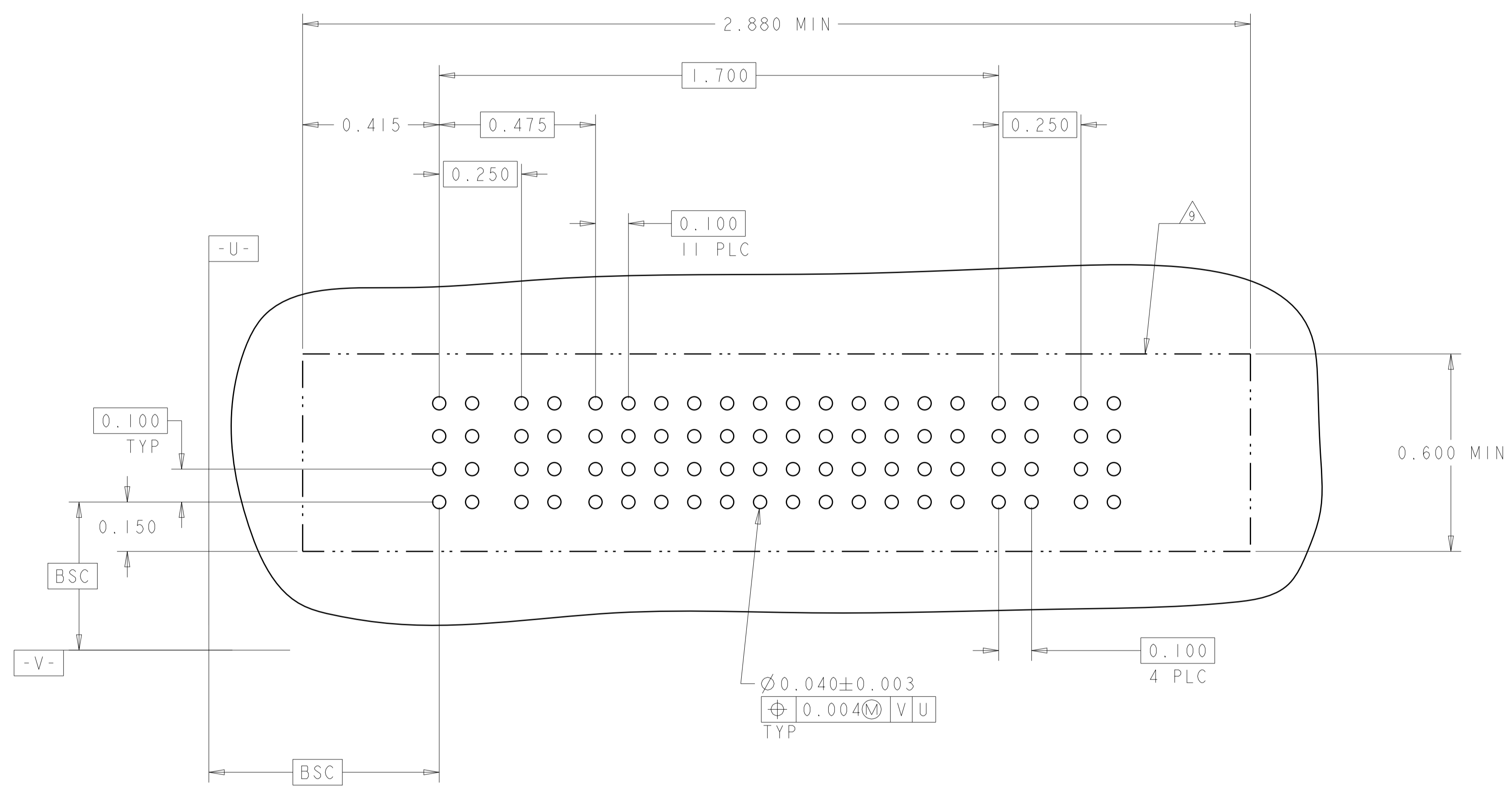

THIS DRAWING IS A CONTROLLED DOCUMENT.		DWN J. McCLINTON 23MAR2005	 TE Connectivity
DIMENSIONS: INCH		CHK D. TROUT 23MAR2005	
TOLERANCES UNLESS OTHERWISE SPECIFIED:		APVD B. WHYNE 23MAR2005	NAME VERTICAL HEADER ASSEMBLY, W/GUIDES, PRESS FIT, TYPE PSP MULTI-BEAM XL
0 PLC ±. 2 PLC ±.01 3 PLC ±.005 4 PLC ±.0020 ANGLES ±.7°		PRODUCT SPEC 108-1973	SIZE 114-13038
MATERIAL		APPLICATION SPEC	RESTRICTED TO
FINISH		WEIGHT	SCALE 3:1 SHEET 22 OF 22 REV P7
Customer Drawing		SIZE CAGE CODE DRAWING NO A100779C=6600333	